

*Dieters*

File Number Genl-01  
Form A24-3069-1  
REG. NR. 1640082

**IBM**

**Systems Reference Library**

**Tape Input-Output Instructions**

This publication contains a description of the instructions used by the data processing system to operate the tape units attached to it.

The instructions for the following tape units are included in this publication:

- IBM 729 Magnetic Tape Unit
- IBM 7330 Magnetic Tape Unit
- IBM 7340 Hypertape Drive, Model 2
- IBM 1011 Paper Tape Reader
- IBM 1012 Tape Punch
- IBM 7335 Magnetic Tape Unit

Timing information is also included on the 729, 7330, and 7335 tape units.

MAJOR REVISION (OCTOBER, 1963)

This publication, Form A24-3069-1, replaces Form A24-3069-0, and the following Technical Newsletter: N24-0137.  
Refer to IBM 1401/1460 Bibliography, Form A24-1495, or IBM 1440 Bibliography, Form A24-3005, for other publications.

© 1960, 1961, 1962, and 1963 by International Business Machines Corporation

Copies of this and other IBM publications can be obtained through IBM Branch Offices.  
Address comments regarding the content of this publication to IBM Product Publications, Endicott, New York

<b>Magnetic-Tape Operations</b> .....	5	<b>IBM 1012 Tape Punch</b> .....	26
Tape Units .....	5	Instructions .....	26
Data Flow .....	5	Write on Tape Punch .....	26
Magnetic-Tape Instructions .....	5	Tape Punch Read Back Check .....	26
Read Tape .....	5	Backspace Tape .....	26
Read Tape with Word Marks .....	6	Backspace Tape and Branch .....	27
Write Tape .....	6	Branch if in Backspace Operation .....	27
Write Tape with Word Marks .....	7	Branch if Tape Punch Ready .....	27
Backspace Tape Record .....	7	Branch if Tape Punch Not Ready to Accept Data .....	27
Skip and Blank Tape .....	8	Branch if Tape Punch is Not Ready to Read .....	28
Write Tape Mark .....	8	Branch if Tape Punch Overextended .....	28
Diagnostic Read .....	9	Branch if Supply Reel Low or Chad Box Full .....	29
Rewind Tape .....	9	IBM 1012 Programming Concepts .....	29
Rewind Tape and Unload .....	9	1. Move Character from Record into Test Location .....	29
Branch if End of Reel .....	10	2. Decode to a Table Address .....	30
Branch if Tape Error .....	10	3. Get Table Argument for Punching .....	30
Magnetic-Tape Operating Considerations .....	11	4. Punch Character in Tape .....	31
IBM 729 Magnetic Tape Unit .....	11	5. Read-Check .....	31
IBM 7330 Magnetic Tape Unit .....	11	6. End-of-Record Routine .....	32
Magnetic -Tape Timing .....	11	7. Automatic Error Correction .....	32
IBM 729 II Tape Timings .....	12	8. End-of-Reel Routine .....	33
IBM 729 IV Tape Timings .....	13	9. Five-Track Tape Operation .....	33
IBM 729 V Tape Timings .....	14	<b>IBM 7335 Magnetic Tape Unit, Models 1 and 2</b> .....	36
IBM 729 VI Tape Timings .....	15	Data Flow .....	36
IBM 7330 Tape Timings .....	15	Magnetic-Tape Instructions .....	36
<b>IBM 7340 Hypertape Drive</b> .....	18	Read Tape .....	36
Instructions .....	18	Read Tape with Word Marks .....	37
Start Control .....	18	Write Tape .....	37
Start Sense .....	18	Write Tape with Word Marks .....	37
Start Read .....	20	Backspace Tape Record .....	38
Start Write .....	22	Skip and Blank Tape .....	38
Branch if Indicator On .....	22	Write Tape Mark .....	38
Response .....	22	Diagnostic Read .....	39
<b>IBM 1011 Paper Tape Reader</b> .....	24	Rewind Tape .....	39
Instructions .....	24	Rewind Tape and Unload .....	39
Read from Paper Tape .....	24	Branch if End of Reel .....	39
Read from Paper Tape with Word Marks .....	24	Branch if Tape Error .....	40
Branch if Input/Output Indicator On .....	25	Read Binary Tape .....	40
Branch if Paper Tape Reader Ready .....	25	Write Binary Tape .....	41
		Magnetic-Tape Timing .....	41
		Read Operation Timing .....	41
		Write Operation Timing .....	42
		<b>Index of Instructions</b> .....	43

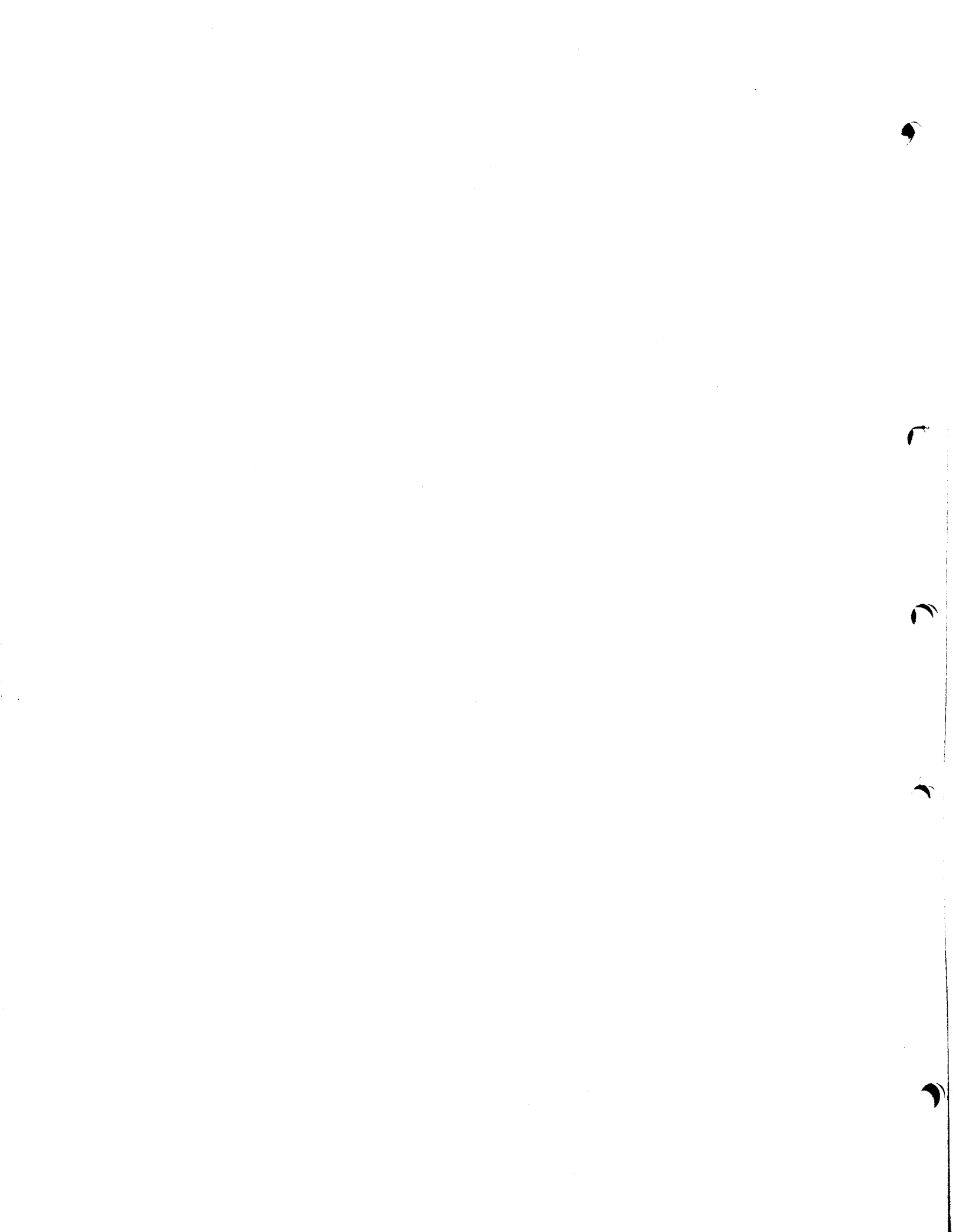

## Magnetic-Tape Operations

### Tape Units

#### IBM 729 MAGNETIC TAPE UNIT (Figure 1)

The 1401 system can use either of four models of the IBM 729 Magnetic Tape Units (Model II, Model IV, Model V, and Model VI). (The Model VI operates at Model IV speeds only.) The 1460 system can use 729 II, 729 IV, 729 V, or 729 VI magnetic-tape units. Either tape-oriented system can accommodate as many as six IBM 729 Tape Units which are attached to the tape adapter on the 1401 (attached to the 1461 on the 1460). The IBM 729 dual density tape unit makes it possible for the IBM 729 tape unit to operate with magnetic tapes recorded at either 200, 556, or 800 characters per inch.

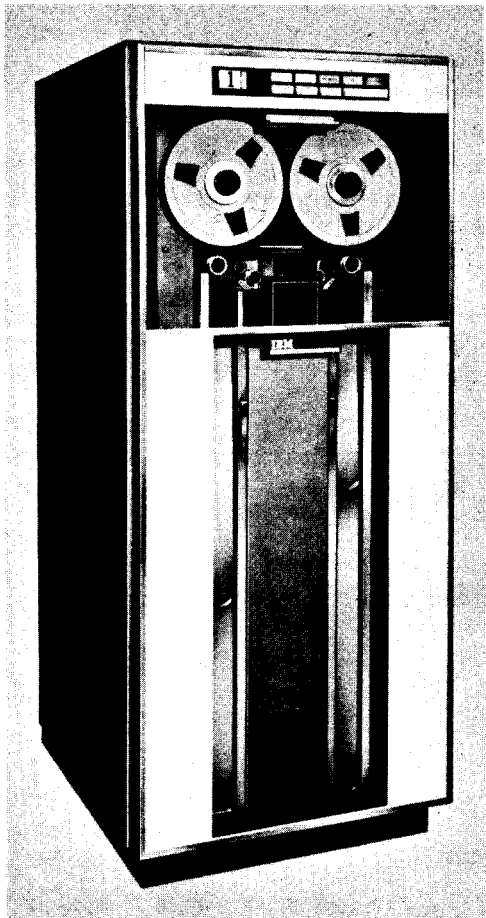

Figure 1. IBM 729 Magnetic Tape Unit

#### IBM 7330 MAGNETIC TAPE UNIT (Figure 2)

The 1401 and 1460 systems can also use the 7330 tape units as an input-output medium. The primary difference between the 7330 and the 729 tape units is the processing speed.

### Data Flow

IBM magnetic-tape units function in the systems as both input and output devices. They transport the magnetic tape and accomplish the actual reading and writing of information, as directed by outside control from the stored program.

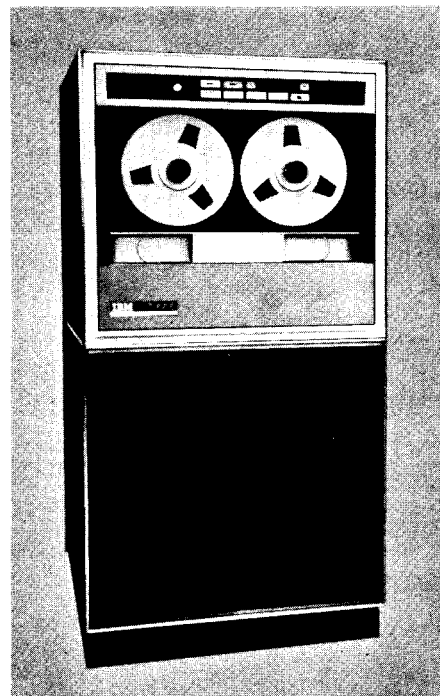

Figure 2. IBM 7330 Magnetic Tape Unit

## Magnetic-Tape Instructions

### Read Tape

#### Instruction Format.

Mnemonic	Op Code	A-address	B-address	d-character
SPS MU	<u>M</u>	%Ux	xxx	R
A RT				

**Function.** The tape unit specified in the A-address is started. The d-character specifies a tape read operation. The B-address specifies the high-order position of the tape read-in area of storage. The machine

begins to read magnetic tape, and continues to read until either an inter-record gap in the tape record or a group-mark with a word-mark in core storage is sensed. The inter-record gap indicates the end of the tape record, and a group-mark (code CBA 8421) is inserted in core storage at this point.

If the group-mark with a word-mark occurs before the inter-record gap is sensed, the transfer of data from tape stops, but tape movement continues until the inter-record gap is sensed.

**Word Marks.** Word marks are not affected.

**Timing.**  $T = N (L_I + 1) \text{ ms} + T_M$ . Time varies for type of tape unit and tape density used (see *Timing* section).  $N = .0115$  (1401),  $.006$  (1460)

**Address Registers After Operation.**

I-Add. Reg.      A-Add. Reg.      B-Add. Reg.  
NSI              %4x              Group-mark + 1

**Example.** Read the record from tape unit 2 (labeled 2) into core storage. The high-order tape-record character is moved to INPUT (0419), the next character is moved to the next higher position (0420), etc., until transfer of data is stopped by an inter-record gap in the tape record, or a group-mark with a word-mark in core storage (Figure 3).

SPS				(A) OPERAND				(B) OPERAND			
LINE	COUNT	LABEL	OPERATION	ADDRESS	CHAR. ADJ.	CHAR. ADJ.	ADDRESS	CHAR. ADJ.	CHAR. ADJ.	ADDRESS	CHAR. ADJ.
2	0	2	RT	0419			0420				
0	0	0									

Autocoder		OPERAND									
Label	Operation	25	30	35	40	45	50	55	60	65	70
	RT	2	INPUT								

Assembled Instruction: M %U2 419 R

Figure 3. Read Tape (Move Operation)

**Read Tape with Word Marks**

**Instruction Format.**

Mnemonic    Op Code    A-address    B-address    d-character  
SPS LU      L        %Ux        xxx        R  
A RTW

**Function.** This is the same as the read tape operation, except that word-separator characters on magnetic tape (written during WRITE TAPE WITH WORD MARKS instruction) are translated to word marks during transmission into core storage.

**Word Marks.** A word-separator character read from tape causes a word mark to be associated with the next tape character transferred into core storage (Figure 4).

Tape Positions	A	B	C	D
Tape Code	82	A841	41	C4
1401 Core Storage				
Locations	A	B	C	
1401 Meaning	0	5	4	
1401 Core Storage				
Code	C82	41W	4	

Figure 4. Word-Separator Character Handling During Read Tape with Word Marks Operation

**Timing.**  $T = N (L_I + 1) \text{ ms} + T_M$ .

**Note.** If a record has been written on tape by a WRITE TAPE WITH WORD MARKS instruction, it should be read back by a READ TAPE WITH WORD MARKS instruction so that word separator characters will be translated to word marks.

**Address Registers After Operation.**

I-Add. Reg.      A-Add. Reg.      B-Add. Reg.  
NSI              %4x              Group-mark + 1

**Example.** Read the record from tape unit 5 (labeled 5) into core storage, and insert word marks where word-separator characters exist in the tape record. The high-order character is moved to INREC1 (0518), the next character is moved to the next higher position (0519), etc., until the transfer of data is stopped by an inter-record gap in the tape record, or until a group-mark with a word-mark is sensed in core storage (Figure 5).

SPS				(A) OPERAND				(B) OPERAND			
LINE	COUNT	LABEL	OPERATION	ADDRESS	CHAR. ADJ.	CHAR. ADJ.	ADDRESS	CHAR. ADJ.	CHAR. ADJ.	ADDRESS	CHAR. ADJ.
5	0	5	RTW	0518			0519				
0	0	0									

Autocoder		OPERAND									
Label	Operation	25	30	35	40	45	50	55	60	65	70
	RTW	5	INREC1								

Assembled Instruction: L %U5 518 R

Figure 5. Read Tape with Word Marks (Load Operation)

**Write Tape**

**Instruction Format.**

Mnemonic    Op Code    A-address    B-address    d-character  
SPS MU      M        %Ux        xxx        W  
A WT

**Function.** The tape unit designated in the A-address is started. The d-character specifies a tape write operation. The data from core storage is written on the tape record. The B-address specifies the high-order position of the record in storage. A group-mark with a word-mark in core storage stops the operation. The group-mark with a word-mark causes an inter-record gap on the tape.

**Word Marks.** Word marks are not affected.

**Timing.**  $T = N (L_I + 1) \text{ ms} + T_M$ .

**Note.** If a group-mark with a word-mark is the first character of B-address, the tape-adaptor unit and the tape unit will hang up. The condition can be reset by pressing the start-reset key if the tape-select switch on the system console is in the N (normal) position.

**Address Registers After Operation.**

I-Add. Reg.          A-Add. Reg.          B-Add. Reg.  
NSI                    %4x                    Group-mark + 1

**Example.** Transfer the contents of core storage to tape unit 3 (labeled 3), starting at the location labeled OUTPUT (0525) and ending at the location of the first group-mark with a word-mark (Figure 6).

SPS		(A) OPERAND										(B) OPERAND									
LINE	COUNT	LABEL	OPERATION	ADDRESS		CHAR. ADJ.	IR	ADDRESS		CHAR. ADJ.	IR	ADDRESS		CHAR. ADJ.	IR	d					
3	0	3	MV	0525	0525			0525	0525			0525	0525								

Autocoder										
Label	Operation	OPERAND								
3	MV	0525	0525	0525	0525	0525	0525	0525	0525	0525

Assembled Instruction: M %U3 525 W

Figure 6. Write Tape (Move Operation)

### Write Tape with Word Marks

**Instruction Format.**

Mnemonic	Op Code	A-address	B-address	d-character
SPS LU	<u>L</u>	%Ux	xxx	W
A	WTW			

**Function.** This is the same as the write tape operation except that the WRITE TAPE WITH WORD MARKS instruction affects word marks in core storage.

**Word Marks.** A word mark associated with any position in core storage causes a word-separator character (A841) to be written automatically on tape, one character ahead of that which contained the word mark. Thus, word marks are translated to word-separator characters for tape storage (Figure 7).

1401 Core Storage				
Locations	A	B	C	
1401 Core Storage				
Code	C82	41W	4	
1401 Meaning	0	5	4	
Tape Positions	A	B	C	D
Tape Code	82	A841	41	C4

Figure 7. Word-Separator Character Handling During Write Tape with Word Marks Operation

**Timing.**  $T = N (L_I + 1) \text{ ms} + T_M$ .

**Note.** Load operations must be used when word marks are needed for identification in tape storage. If tape is written by a WRITE TAPE WITH WORD MARKS instruction, it must be read back by a READ TAPE WITH WORD MARKS instruction to insure proper translation between the tape and core storage.

**Address Registers After Operation.**

I-Add. Reg.          A-Add. Reg.          B-Add. Reg.  
NSI                    %4x                    Group-mark + 1

**Example.** Transfer the contents of core storage to tape unit 6 (labeled 6). Insert a word-separator character where word marks exist in core storage, beginning at OUTREC (0696) and ending at the first group-mark with a word-mark in core storage (Figure 8).

SPS		(A) OPERAND										(B) OPERAND									
LINE	COUNT	LABEL	OPERATION	ADDRESS		CHAR. ADJ.	IR	ADDRESS		CHAR. ADJ.	IR	ADDRESS		CHAR. ADJ.	IR	d					
3	0	6	LU	0696	0696			0696	0696			0696	0696								

Autocoder										
Label	Operation	OPERAND								
6	LU	0696	0696	0696	0696	0696	0696	0696	0696	0696

Assembled Instruction: L %U6 696 W

Figure 8. Write Tape with Word Marks

### Backspace Tape Record

**Instruction Format.**

Mnemonic	Op Code	A-address	d-character
SPS CU	<u>U</u>	%Ux	B
A	BSP		

**Function.** The tape unit specified in the A-address backspaces over one tape record. The first inter-record gap (IRG) encountered stops the backspace operation specified by the d-character, B.

**Word Marks.** Word marks are not affected.

**Timing.**  $T = N (L_I + 1) \text{ ms} + T_M$ .

**Note.** Processing unit not interlocked during tape-movement time.

### Address Registers After Operation.

I-Add. Reg.      A-Add. Reg.      B-Add. Reg.  
 NSI              %4x              dbb

Example. Backspace tape unit 4 (labeled 4) until an IRG is sensed (Figure 9).

SPS		(A) OPERAND										(B) OPERAND									
LINE	COUNT	LABEL	OPERATION	ADDRESS		±	CHAR. ADJ.	±	CHAR. ADJ.	ADDRESS		±	CHAR. ADJ.	±	CHAR. ADJ.	d					
3	6	7	8	13	14	15	16	17	23	24	25	26	27	28	34	35	36				
0	1	0		C	U												4				

Autocoder		OPERAND									
Label	Operation	25	30	35	40	45	50				
BSP	4										

Assembled Instruction: U %U4 B

Figure 9. Backspace Tape Record

### Skip and Blank Tape

#### Instruction Format.

Mnemonic      Op Code      A-address      d-character  
 SPS CU              U              %Ux              E  
 A SKP

Function. The tape unit, designated by the A-address, spaces forward and erases approximately 3.5 inches of tape. The actual skip occurs when the next WRITE TAPE instruction is given. This instruction makes it possible to bypass defective tape areas.

Word Marks. Word marks are not affected.

Timing.  $T = N (L_I + 1) \text{ ms}$ . Processing can continue immediately after this operation. However, 40.5 ms for IBM 729 II, 27 ms for IBM 729 IV, 40.5 ms for IBM 729 V, 27 ms for IBM 729 VI (1460 only), and 108 ms for an IBM 7330 must be added to the next WRITE TAPE instruction time.

Notes. The SKIP AND BLANK TAPE instruction should be given immediately preceding a WRITE TAPE instruction for the tape unit specified by both instructions.

The processing unit is not interlocked during tape-movement time.

#### Address Registers After Operation.

I-Add. Reg.      A-Add. Reg.      B-Add. Reg.  
 NSI              %4x              dbb

Example. Erase tape on tape unit 5 (labeled 5) when the next write operation is ordered for that unit (Figure 10).

SPS		(A) OPERAND										(B) OPERAND									
LINE	COUNT	LABEL	OPERATION	ADDRESS		±	CHAR. ADJ.	±	CHAR. ADJ.	ADDRESS		±	CHAR. ADJ.	±	CHAR. ADJ.	d					
3	6	7	8	13	14	15	16	17	23	24	25	26	27	28	34	35	36				
0	1	0		C	U												5				

Autocoder		OPERAND									
Label	Operation	25	30	35	40	45	50				
SKP	5										

Assembled Instruction: U %U5 E

Figure 10. Skip and Blank Tape

### Write Tape Mark

#### Instruction Format.

Mnemonic      Op Code      A-address      d-character  
 SPS CU              U              %Ux              M  
 A WTM

Function. This instruction causes a tape mark character (8421) to be recorded immediately following the last record on tape. When the tape mark is read back from a tape, the end-of-reel indicator is turned on. This signals the system program that the end of a major group of records has been reached (end-of-file) or the end of utilized tape has been reached.

Word Marks. Word marks are not affected.

Timing.  $T = N (L_I + 1) \text{ ms} + T_M$ .

Note. Processing unit not interlocked during tape-movement time.

#### Address Registers After Operation.

I-Add. Reg.      A-Add. Reg.      B-Add. Reg.  
 NSI              %4x              dbb

Example. Insert a tape mark on the tape in tape unit 3 (labeled 3), Figure 11.

SPS		(A) OPERAND										(B) OPERAND									
LINE	COUNT	LABEL	OPERATION	ADDRESS		±	CHAR. ADJ.	±	CHAR. ADJ.	ADDRESS		±	CHAR. ADJ.	±	CHAR. ADJ.	d					
3	6	7	8	13	14	15	16	17	23	24	25	26	27	28	34	35	36				
0	1	0		C	U												3				

Autocoder		OPERAND									
Label	Operation	25	30	35	40	45	50				
WTM	3										

Assembled Instruction: U %U3 M

Figure 11. Write Tape Mark



## Diagnostic Read

### Instruction Format.

Mnemonic	Op Code	A-address	d-character
SPS (none)	<u>U</u>	%Bx	A
A (none)			

**Function.** This instruction causes the tape unit specified in the A-address to reposition its tape to the next inter-record gap (IRG) without transmitting any data to core storage. If the tape record contains a first character tape mark, the end-of-file (EOF) indicator is turned on.

This instruction is useful in skipping records or files on tape. The system is free to proceed with internal processing during the tape movement.

The tape operations are interlocked until the check character of the record being skipped is sensed.

**Word Marks.** Word marks are not affected.

**Timing.**  $T = N(L_I + 1) \text{ ms} + T_M$ .

**Note.** Processing unit not interlocked during tape-movement time.

## Rewind Tape

### Instruction Format.

Mnemonic	Op Code	A-address	d-character
SPS CU	<u>U</u>	%Ux	R
A RWD			

**Function.** This instruction is usually given after an end-of-reel condition, and causes the selected tape unit to rewind its tape. When the operation is initiated, the tape unit is, in effect, disconnected from the system.

**Word Marks.** Word marks are not affected.

**Timing.**  $T = N(L_I + 1) \text{ ms}$ . Rewind time is 1.2 minutes per 2,400-foot reel for the IBM 729 II, .9 minute for the IBM 729 IV, 1.2 minutes for the IBM 729 V, .9 minute for the IBM 729 VI (1460 only), and 13.3 minutes for the IBM 7330, but it is not calculated with program time. Processing can continue approximately 10 ms after this instruction is interpreted.

**Note.** Processing unit not interlocked during tape-movement time.

### Address Registers After Operation.

I-Add. Reg.	A-Add. Reg.	B-Add. Reg.
NSI	%4x	dbb

**Example.** Rewind the tape in tape unit 1 (labeled 1), Figure 12.

## SPS

LINE	COUNT	LABEL	OPERATION	(A) OPERAND				(B) OPERAND				d	
				ADDRESS	±	CHAR. ADJ.	±	ADDRESS	±	CHAR. ADJ.	±		
0	1		CU	%01									

## Autocoder

Label	Operation	OPERAND							
RWD	U								

Assembled Instruction: U %01 R

Figure 12. Rewind Tape

## Rewind Tape and Unload

### Instruction Format.

Mnemonic	Op Code	A-address	d-character
SPS CU	<u>U</u>	%Ux	U
A RWU			

**Function.** This instruction causes the tape unit specified in the A-address to rewind its tape. At the end of the rewind, the tape is out of the vacuum columns, and the reading mechanism is disengaged. The unit is effectively disconnected from the system, and is not available again until the operator restores it to a ready status.

**Word Marks.** Word marks are not affected.

**Timing.**  $T = N(L_I + 1) \text{ ms}$ . Rewind time is 1.2 minutes per 2,400-foot reel for the IBM 729 II, .9 minute for the IBM 729 IV, 1.2 minutes for the 729 V, .9 minute for the 729 VI (1460 only), and 2.2 minutes for the IBM 7330, but it is not calculated with program time.

Processing can continue approximately 10 ms after this instruction is interpreted by a system using IBM 729 tape units, or 4.5 seconds in a system using IBM 7330 tape units.

**Note.** Processing unit not interlocked during tape-movement time.

### Address Registers After Operation.

I-Add. Reg.	A-Add. Reg.	B-Add. Reg.
NSI	%4x	dbb

**Example.** Rewind the tape in tape unit 5 (labeled 5), and make it unavailable to the stored program, at the completion of the rewind operation (Figure 13).

LINE	COUNT	LABEL	OPERATION	(A) OPERAND				(B) OPERAND				d									
				ADDRESS	CHAR. ADJ.	ED	RD	ADDRESS	CHAR. ADJ.	ED	RD										
3	0		RWU	15		20		25		30		35		40		45		50			
0	1	0																			

Label	Operation	OPERAND
	RWU	15

Assembled Instruction: **U** %U5 U

Figure 13. Rewind Tape and Unload

### Branch if End of Reel

#### Instruction Format.

Mnemonic	Op Code	I-address	d-character
SPS B	<b>B</b>	xxx	K
A BEF			

**Function.** The end-of-reel indicator (EOR) turns on in the system processing unit if a tape mark is read by the system or if a *reflective spot* is sensed during a write tape operation. This instruction tests the indicator and causes an automatic branch to the I-address if the indicator is ON. If it is OFF, the program continues normally.

**Word Marks.** Word marks are not affected.

#### Timing.

Without Indexing:

$$T = N (L_I + 1) \text{ ms.}$$

With Indexing:

$$T = N (L_I + 2) \text{ ms.}$$

**Note.** This instruction must be executed immediately following a tape read or tape write operation to ensure correct results and reset the EOR indicator OFF, if it is ON. If another tape unit is selected before a BRANCH IF END-OF-REEL INDICATOR ON instruction is executed, the indicator remains ON and a false EOR condition specifying the wrong tape unit results.

#### Address Registers After Operation.

I-Add. Reg.	A-Add. Reg.	B-Add. Reg.
NSI	BI	dbb

**Example.** Test the tape unit just used for an end-of-reel condition. If there is an EOR condition, branch to TAPER1 (0685) for the next instruction. If no EOR exists, continue the program with the next sequential instruction (Figure 14).

LINE	COUNT	LABEL	OPERATION	(A) OPERAND				(B) OPERAND				d									
				ADDRESS	CHAR. ADJ.	ED	RD	ADDRESS	CHAR. ADJ.	ED	RD										
3	0		B	15		20		25		30		35		40		45		50			
0	1	0																			

Label	Operation	OPERAND
	B	TAPER1
	BEF	TAPER2

Assembled Instruction: **B** 685 K

Figure 14. Branch If End of Reel

### Branch if Tape Error

#### Instruction Format.

Mnemonic	Op Code	I-address	d-character
SPS B	<b>B</b>	xxx	L
A BER			

**Function.** If an error occurs in transmission between a tape unit and the system during a tape read or tape write operation, an error indicator turns on in the system and the tape light on the console glows red. This instruction tests the error indicator, and branches to the I-address for the next instruction if the indicator is ON. If it is OFF, the program continues with the next sequential instruction.

**Word Marks.** Word marks are not affected.

#### Timing.

Without Indexing:

$$T = N (L_I + 1) \text{ ms.}$$

With Indexing:

$$T = N (L_I + 2) \text{ ms.}$$

**Notes.** The BRANCH IF TAPE ERROR instruction must be given after a tape read or write operation, because any tape operation on any tape unit causes the indicator to turn off. The information read from tape always enters core storage with odd-bit parity. Therefore, the tape read-in area need not be cleared after a tape read error has occurred.

#### Address Registers After Operation.

I-Add. Reg.	A-Add. Reg.	B-Add. Reg.
NSI	BI	dbb

**Example.** Read a tape record from the tape unit 3 (labeled 3) into core-storage area labeled TAPEIN (0629) and test for a tape error. If there is an error, branch to TAPER2 (0539) for the next instruction. If there is no error, continue processing with the next sequential instruction (Figure 15).

LINE	COUNT	LABEL	OPERATION	(A) OPERAND				(B) OPERAND				d									
				ADDRESS	CHAR. ADJ.	ED	RD	ADDRESS	CHAR. ADJ.	ED	RD										
3	0		MU	15		20		25		30		35		40		45		50			
0	1	0																			
0	2	0																			

Label	Operation	OPERAND
	RT	3, TAPEIN
	BER	TAPER2

Assembled Instruction: **M** %U3 629 R  
**B** 539 L

Figure 15. Branch If Tape Error

## Magnetic-Tape Operating Considerations

### IBM 729 Magnetic Tape Unit

If the 729 is in *write* status, to change to *read* status the program must *backspace* over those records that are to be read. The tape unit must then be changed back to *write* status ( $W_1, W_2, W_3, B_3, B_2, R_2, R_3, W_4, W \dots$ ).

This results in unchecked tape on the first record written after *backspace*.

The 729 cannot be switched directly from write to read status ( $W_1, W_2, R_3, R_4$ ).

If the 729 is in *read* status, the tape unit can be changed directly from read to write status ( $R_1, R_2, W_3, W_4$ ).

### IBM 7330 Magnetic Tape Unit

If the 7330 is in *write* status, to change to *read* status the program must *backspace* over those records that are to be read. The tape unit must then be changed back to *write* status ( $W_1, W_2, W_3, B_3, B_2, R_2, R_3, W_4, W \dots$ ). This results in unchecked tape on the first record written after *backspace*.

The 7330 cannot be switched directly from write to read status ( $W_1, W_2, R_3, R_4$ ).

If the 7330 is in *read* status, to change to *write* status the program must *backspace* over the last record read and then rewrite that record. The 7330 then continues in write status ( $R_1, R_2, B_2, W_2, W_3, W \dots$ ).

The 7330 cannot be switched directly from read to write status ( $R_1, R_2, W_3, W_4$ ).

Figure 16 is a summary of 1401 and 1460 magnetic-tape operating considerations.

For detailed information concerning magnetic tape and IBM magnetic-tape units, refer to the IBM Reference Manual, *Magnetic Tape Units*, Form A22-6589.

Dust or damage to the magnetic tape is the most frequent cause of errors detected during write operations. Such imperfections are usually isolated; so, in order to skip the defective section, the system has been provided with an instruction that causes the tape to space forward approximately 3.5 inches when the next write operation is initiated. While the tape is passed, this short length is erased so that extraneous data is not sensed when the tape is read. The tape-write operation continues after the skip is completed.

When writing from load point, a space of 3.5 inches also occurs prior to writing the record, and start time is increased about 27 milliseconds.

### Magnetic-Tape Timing

All tape units in a 1401 system are under the control of a tape-adapter unit (a 1461 on the 1460 system). The tape-adapter unit (TAU) can control the operations of only one tape unit at a time. If one tape unit is busy, no other tape unit can be used until all operations on the

STATUS	OPERATION	729	CAN BE PERFORMED		
			REMARKS	7330	REMARKS
Read	$R_1 B_1 W_1 W_2 W \dots$	Yes	Updating tape label	Yes	Updating tape label
	$R_1 R_2 \text{ Skip } W_3 W \dots$	Yes	Results in unchecked tape	Yes	Results in unchecked tape Skip must be over known blank area
	$R_1 R_2 W_3 W \dots$	Yes	Unchecked tape in record $W_3$	No	Write head is over first part of next record ( $W_2$ )
	$R_1 B_1 W_1 R_2$	No	Changing from W to R causes bits in the inter-record gap	No	Changing from W to R causes bits in the inter-record gap
Write	$W_1 B_1 R_1 W_2 W \dots$	Yes	Unchecked tape on record $W_2$	Yes	Unchecked tape on record $W_2$
	$W_1 W_2 \text{ Blank Area } R_3 R \dots$	Not Recom.	Results in bits in the inter-record gap and possible error on $R_3$	Not Recom.	Results in bits in the inter-record gap and possible error on $R_3$
	$W_1 W_2 R_3 R_1$	No	Changing from W to R causes bits in the inter-record gap	No	Changing from W to R causes bits in the inter-record gap
	$W_1 B_1 R_1 R_2$	No	Changing from W to R causes bits in the inter-record gap	No	Changing from W to R causes bits in the inter-record gap
Rewind	$R_3 R_1 R_2 R_w$	Yes		Yes	
	$W_3 W_4 W_5 R_w$	Yes	Causes extraneous bits after $W_5$ (label)	Yes	Causes extraneous bits after $W_5$ (label)

R —read  
W —write  
B —backspace  
R<sub>w</sub> —rewind

Figure 16. Summary of IBM 1401 and 1460 Magnetic Tape Operating Considerations

busy one have been completed. The execute time of a tape instruction varies according to the type and model tape units used in the system.

*C* is the character rate in milliseconds based on the setting of the tape density switch.

*N* is the number of characters in the record.

*CN* is record time (number of characters in the record, times the character rate).

*Start time* is the time necessary for the tape unit to accelerate to operating speed.

*Stop time* is the time necessary for the tape unit to decelerate and stop.

*Record check time* is the time it takes to read or write the check character. This time is based on the read-write head gap (the distance that separates the read and write heads) and the time it takes a single character written on tape to travel from the write head to the read head.

*Load Point Time.* When reading or writing from load point, a space of 3.5 inches occurs prior to reading

or writing a record and the start time is increased about 27 milliseconds.

### IBM 729 II Tape Timings

During a 729 II *read* operation, the tape adapter unit or 1461 is interlocked for  $10.7 + CN$  ms (Figure 17). This includes:

- 10.5 ms – start time
- .2 ms – record check time for high-density tape (.6 for low-density tape)
- $CN$  ms – record time

During the same read operation, the processing unit is interlocked for  $10.5 + CN$  ms. This includes:

- 10.5 ms – start time
- $CN$  ms – record time

Therefore, in a tape-read operation, processing can take place during the 2.1 ms stop time. A tape-transmission-error condition can be recognized .2 ms after the processing interlock is released. If the tape trans-

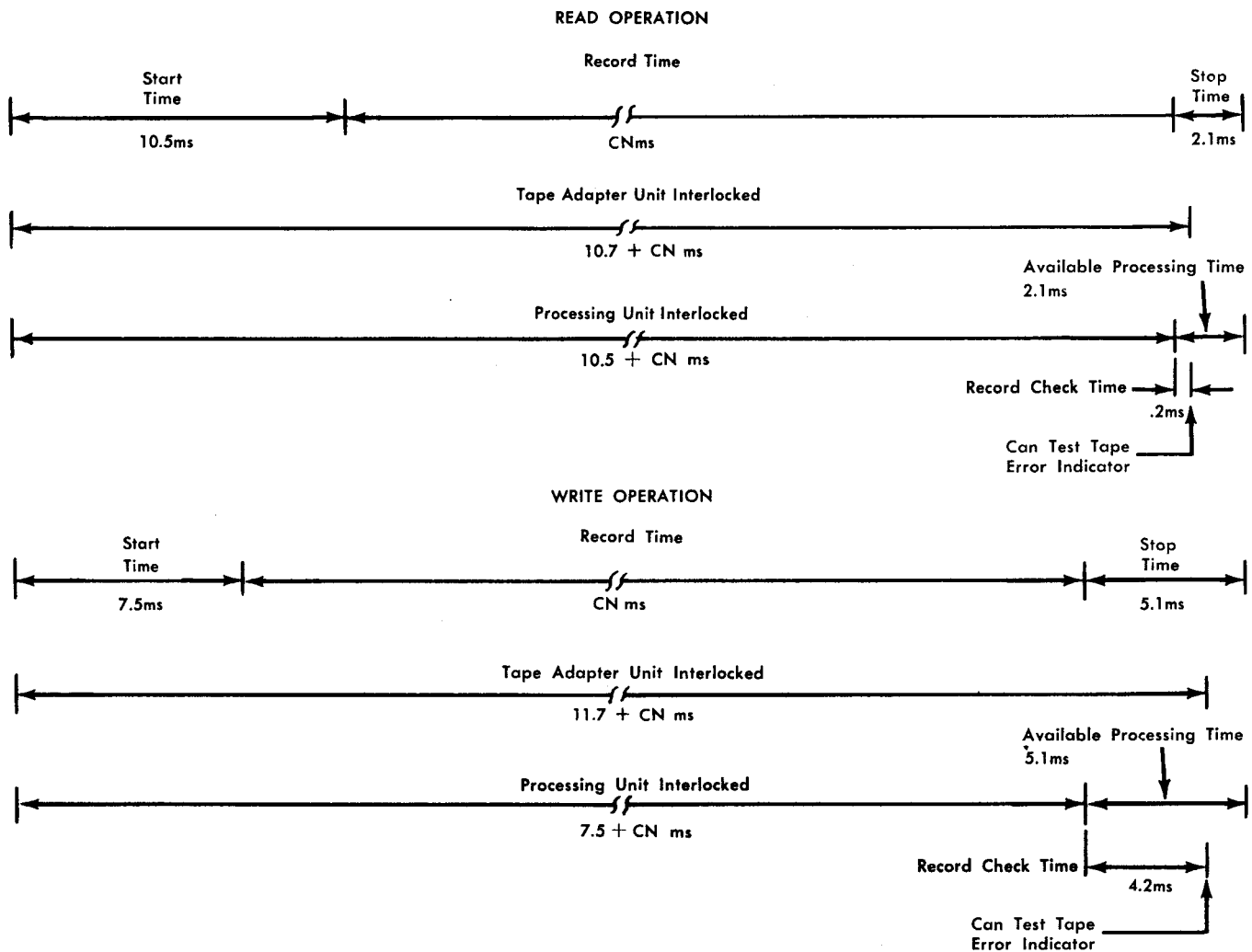

Figure 17. IBM 729, Model II, Read-Write Operation Timings

mission-error-test instruction is given during this .2 ms period, the processing unit is interlocked until the error indicator can be tested.

During a 729 II tape *write* operation, the tape-adapter unit or 1461 is interlocked for  $11.7 + CN$  ms (Figure 17). This includes:

- 7.5 ms – start time
- 4.2 ms – record check time for high-density tape (4.6 for low-density tape)
- CN ms – record time

During the same write operation, the processing unit is interlocked for  $7.5 + CN$  ms. This includes:

- 7.5 ms – start time
- CN ms – record time

Therefore, in a tape-write operation, processing can take place during the 5.1 ms stop time. A tape-transmission-error condition can be recognized 4.2 ms after the processing interlock is released. If the tape-transmission-error-test instruction is given during this 4.2 ms

period, the processing unit is interlocked until the error indicator can be tested. The difference between the .2 ms record check time of reading and the 4.2 ms record check time of writing is due to the read-write head gap time (4.0 ms).

For job-timing estimates of tape read-write operations, the nominal formula  $10.8 + CN$  ms can be used.

### IBM 729 IV Tape Timings

During a 729 IV *read* operation, the tape-adapter unit or 1461 is interlocked for  $6.8 + CN$  ms (Figure 18). This includes:

- 6.7 ms – start time
- .1 ms – record check time for high-density tape (.4 for low-density tape)
- CN ms – record time

During the same read operation, the processing unit is interlocked for  $6.7 + CN$  ms. This includes:

- 6.7 ms – start time
- CN ms – record time

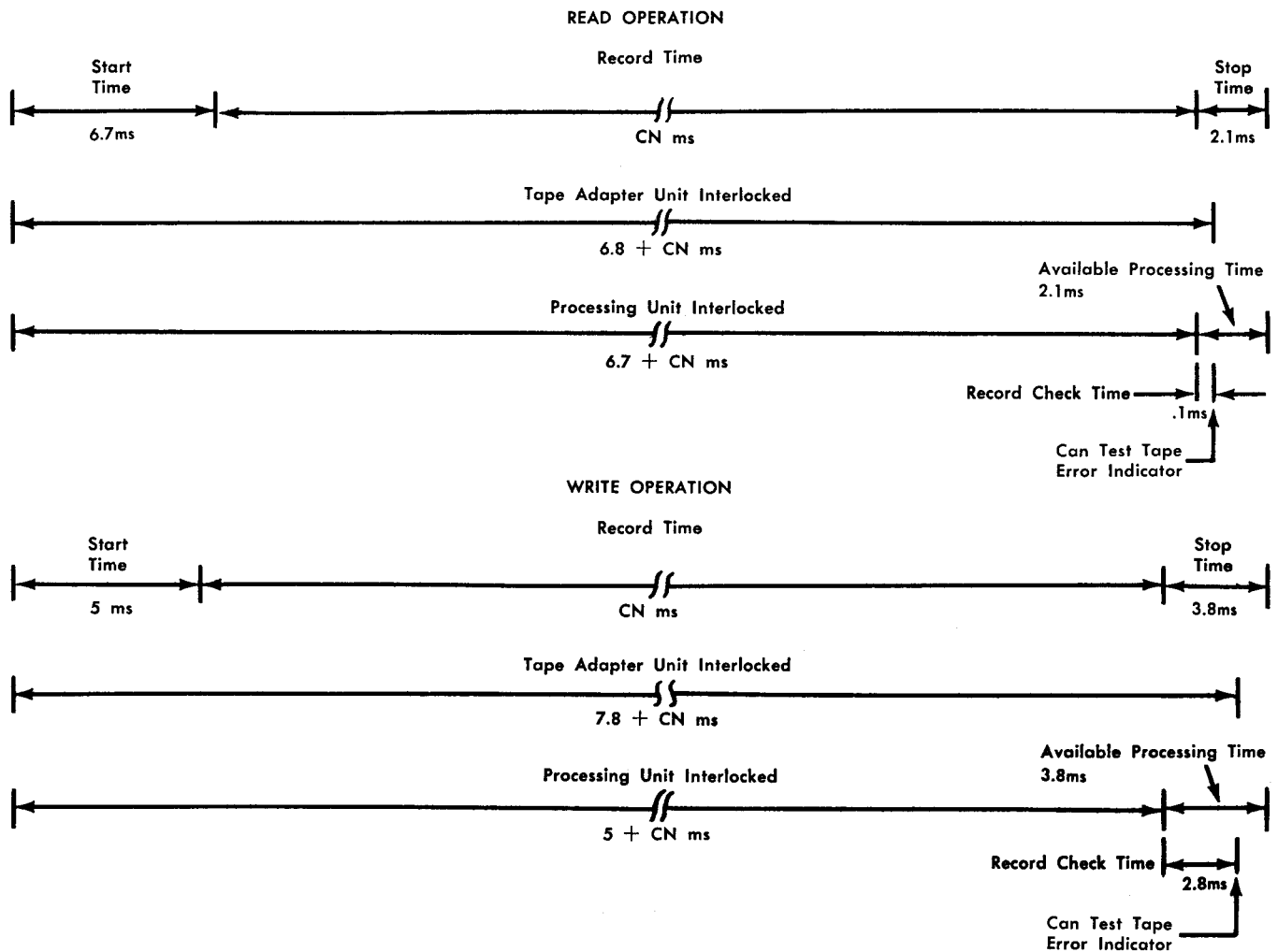

Figure 18. IBM 729, Model IV, Read-Write Operation Timings

Therefore, in a tape-read operation, processing can take place during the 2.1 ms stop time. A tape-transmission-error condition can be recognized .1 ms after the processing interlock is released. If the tape-transmission-error-test instruction is given during this .1 ms period, the processing unit is interlocked until the error indicator can be tested.

During a 729 IV tape *write* operation, the tape-adaptor unit or 1461 is interlocked for  $7.8 + CN$  ms (Figure 18).

This includes:

- 5 ms — start time
- 2.8 ms — record check time for high-density tape (3.0 for low-density tape)
- CN ms — record time

During the same write operation, the processing unit is interlocked for  $5 + CN$  ms. This includes:

- 5 ms — start time
- CN ms — record time

Therefore, in a tape-write operation, processing can take place during the 3.8 ms stop time. A tape-transmission-error condition can be recognized 2.8 ms after the processing interlock is released. If the tape-transmission-error-test instruction is given during this 2.8 ms period, the processing unit is interlocked until the error indicator can be tested. The difference between the .1 ms record check time of reading and the 2.8 ms record check time of writing is due to the read-write head gap time (2.7 ms).

For job-timing estimates of tape read-write operations, the nominal formula  $7.3 + CN$  ms can be used.

### IBM 729 V Tape Timings

During a 729 V read operation, the tape-adaptor unit or 1461 is interlocked for  $10.7 + CN$  ms (Figure 19).

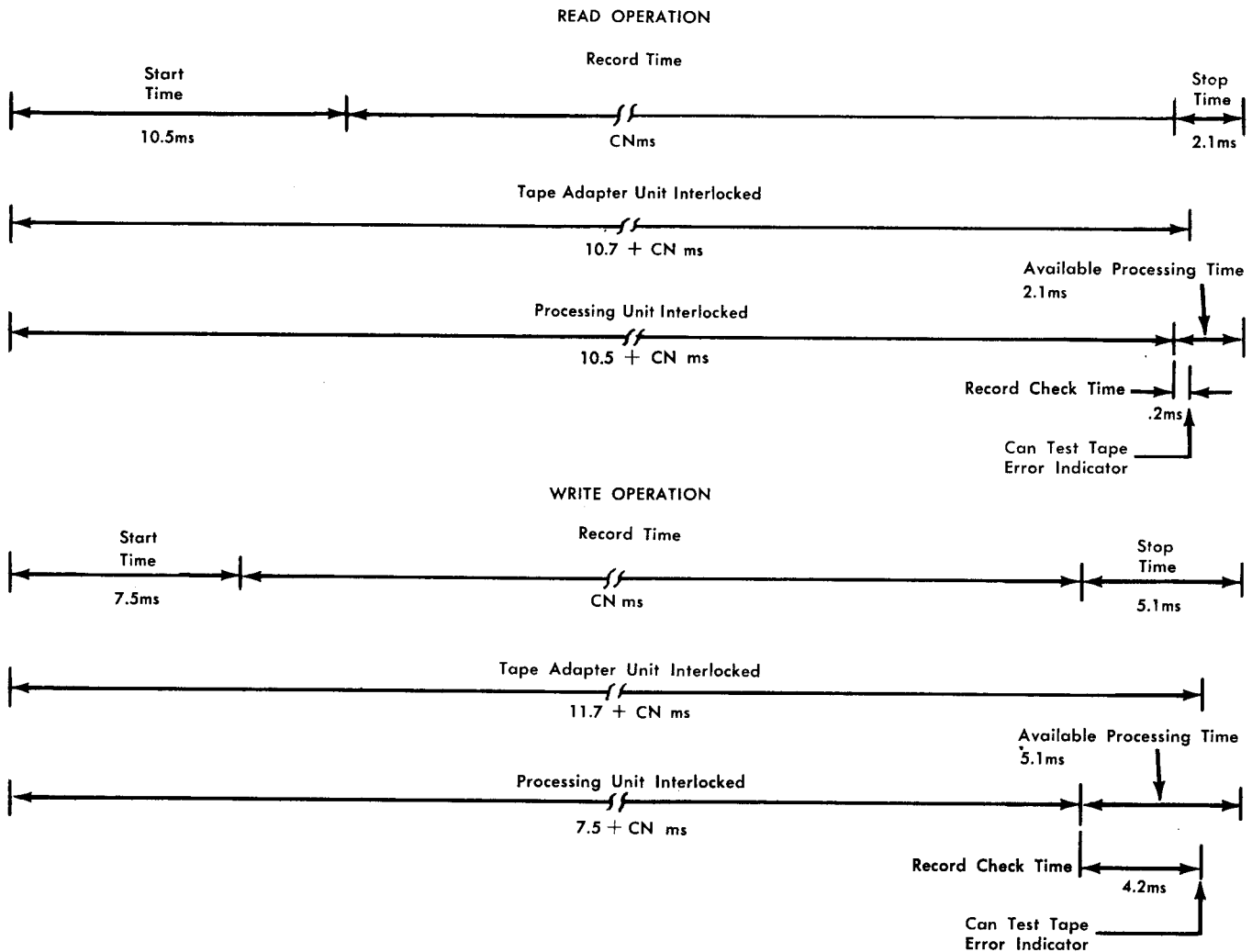

Figure 19. IBM 729, Model V, Read-Write Operation Timings

This includes:

- 10.5 ms – start time
- .2 ms – record check time for high-density tape (.6 for low-density tape)
- CN ms – record time

During the same read operation, the processing unit is interlocked for  $10.5 + \text{CN}$  ms. This includes:

- 10.5 ms – start time
- CN ms – record time

Therefore in a tape-read operation, processing can take place during the 2.1 ms stop time. A tape-transmission-error condition can be recognized .2 ms after the processing interlock is released. If the tape-transmission-error-test instruction is given during this .2 ms period, the processing unit is interlocked until the error indicator can be tested.

During a 729 V write operation, the tape-adaptor unit or 1461 is interlocked for  $11.7 + \text{CN}$  ms (Figure 19). This includes:

- 7.5 ms – start time
- 4.2 ms – record check time for high-density tape (4.6 for low-density tape)

During the same write operation, the processing unit is interlocked for  $7.5 + \text{CN}$  ms. This includes:

- 7.5 ms – start time
- CN ms – record time

Therefore in a tape-write operation, processing can take place during the 5.1 ms stop time. A tape-transmission-error condition can be recognized 4.2 ms after the processing interlock is released. If the tape transmission-error-test instruction is given during this 4.2 ms period, the processing unit is interlocked until the error indicator can be tested. The difference between the .2 ms record check time of reading and the 4.2 ms record check time of writing is due to the read-write head gap time (4.0 ms).

For job-timing estimates of tape read-write operations, the nominal formula  $10.8 + \text{CN}$  ms can be used.

### IBM 729 VI Tape Timings

During a 729 VI read operation, the tape-adaptor unit or 1461 is interlocked for  $6.8 + \text{CN}$  ms (Figure 20). This includes:

- 6.7 ms – start time
- .1 ms – record check time for high-density tape (.4 for low-density tape)
- CN ms – record time

During the same read operation, the processing unit is interlocked for  $6.7 + \text{CN}$  ms. This includes:

- 6.7 ms – start time
- CN ms – record time

Therefore in a tape-read operation, processing can take place during the 2.1 ms stop time. A tape-transmission-error condition can be recognized .1 ms after the processing interlock is released. If the **BRANCH IF TAPE ERROR** instruction is given during this .1 ms period, the processing unit is interlocked until the error indicator can be tested.

During a 729 VI write operation, the tape-adaptor unit or 1461 is interlocked for  $7.8 + \text{CN}$  ms (Figure 20). This includes:

- 5 ms – start time
- 2.8 ms – record check time for high-density tape (3.0 for low-density tape)

During the same write operation, the processing unit is interlocked for  $5 + \text{CN}$  ms. This includes:

- 5 ms – start time
- CN ms – record time

Therefore in a tape-write operation, processing can take place during the 3.8 ms stop time. A tape-transmission-error condition can be recognized 2.8 ms after the processing interlock is released. If the tape-transmission-error-test instruction is given during this 2.8 ms period, the processing unit is interlocked until the error indicator can be tested. The difference between the .1 ms record check time of reading and the 2.8 ms record check time of writing is due to the read-write head gap time (2.7 ms).

For job-timing estimates of tape read-write operations, the nominal formula  $7.3 + \text{CN}$  ms can be used.

### IBM 7330 Tape Timings

During a 7330 tape-read operation, the tape-adaptor unit or 1461 is interlocked for  $20.5 + \text{CN}$  ms (Figure 21). This includes:

- 10.3 ms – start time
- 9.8 ms – stop time
- .4 ms – record check time for high-density tape (1.0 ms for low-density tape)
- CN ms – record time

During the same read operation, the processing unit is interlocked for  $10.4 + \text{CN}$  ms. This includes:

- 10.3 ms – start time
- .1 ms – part of the .4 ms record check time
- CN ms – record time

Therefore, in a tape-read operation, processing can take place during 10.1 ms of stop time and record-check time. A tape-transmission-error condition can be recognized .3 ms after the processing interlock is released.

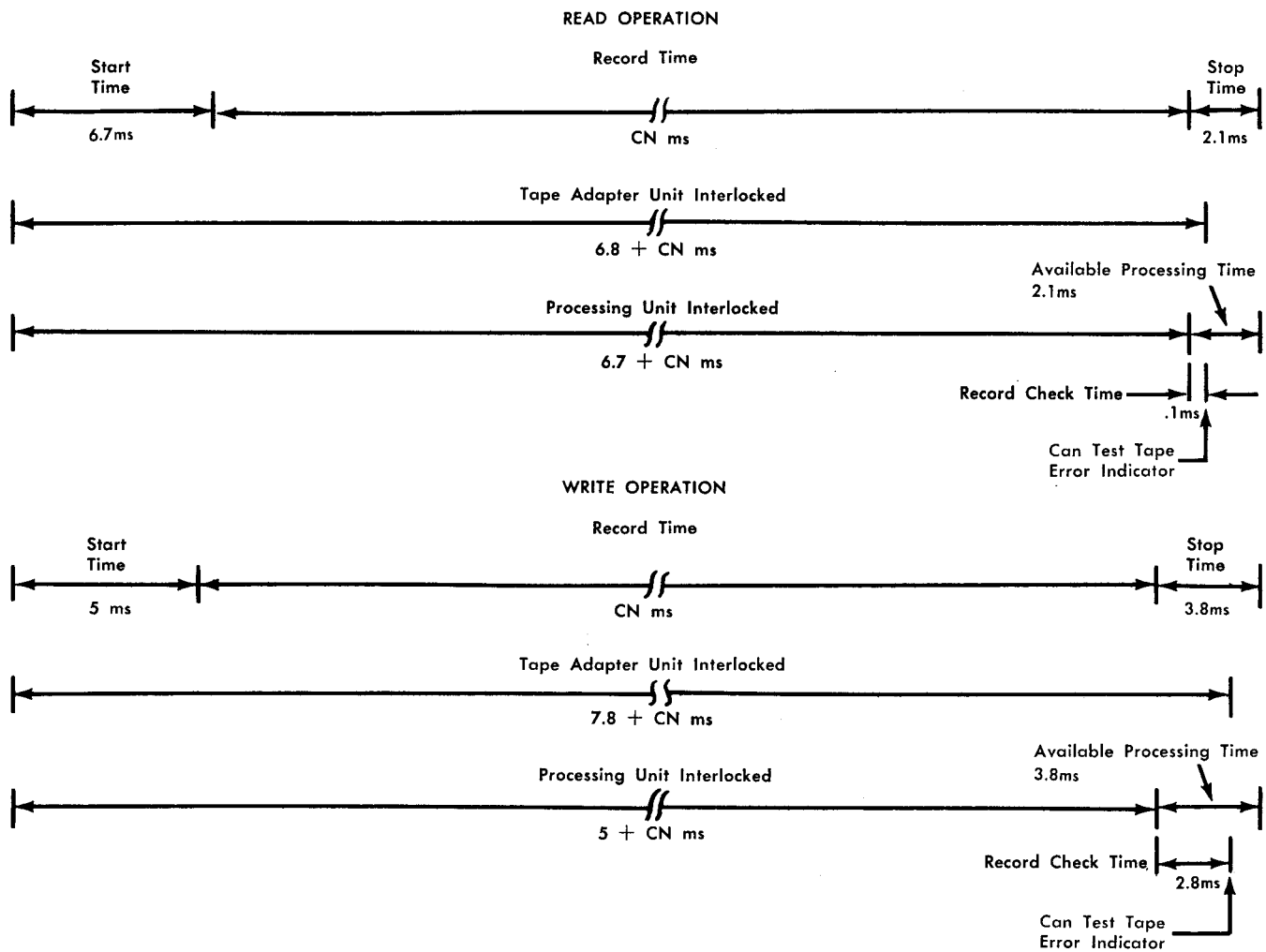

Figure 20. IBM 729, Model VI, Read-Write Operation Timings

During a 7330 tape-write operation, the tape-adaptor unit is interlocked for  $20.3 + CN$  ms (Figure 21). This includes:

- 5.0 ms – start time
- 6.6 ms – stop time
- 8.7 ms – record check time for high-density tape (9.3 ms for low-density tape)
- CN ms – record time

During the same write operation, the processing unit is interlocked for  $5 + CN$  ms. This includes:

- 5.0 ms – start time
- CN ms – record time

Therefore, in a tape-write operation, processing can take place during the 15.3 ms stop time. A tape-transmission-error condition can be recognized 8.7 ms after

the processing interlock is released. If the tape-transmission-test instruction is given during this 8.7 ms period, the processing unit is interlocked until the error indicator can be interrogated. The difference between the .4 ms record check time of reading and the 8.7 ms record check time of writing is due to the read-write head gap time (8.3 ms).

For job-timing estimates of read operations in either high- or low-density, use the formula  $20.1 + C(N + 7)$  ms, where the factor C (7) is the record check time.

For job-timing estimates of write operations in either high- or low-density, use the formula  $19.9 + C(N + 7)$  ms, where the factor C (7) is the record check time, and 8.3 ms of the 19.9 ms is the read-write head gap time.



READ OPERATION

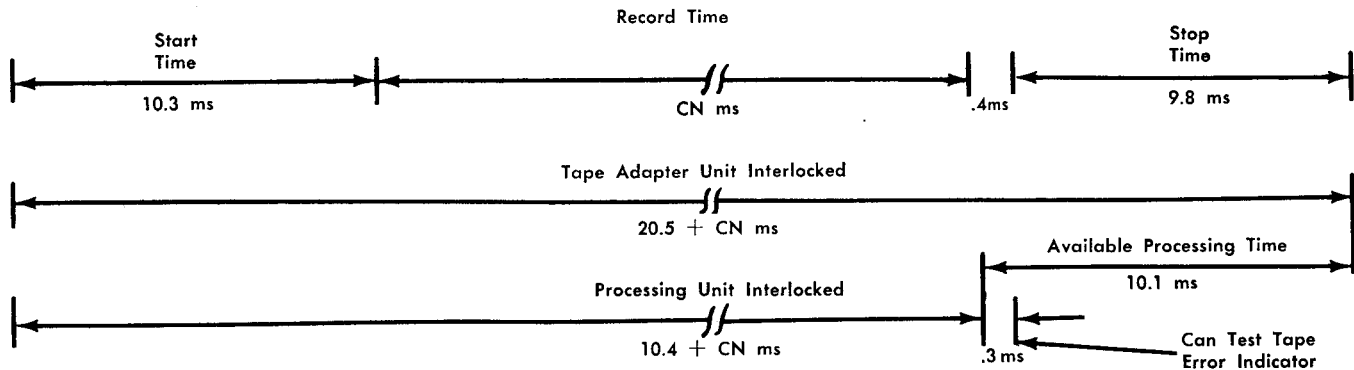

WRITE OPERATION

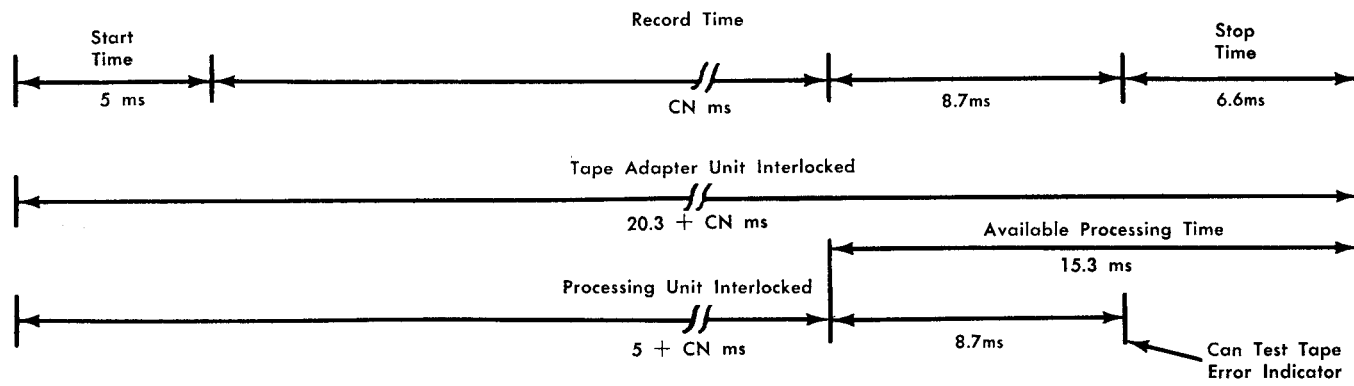

Figure 21. IBM 7330 Read-Write Operation Timings

## IBM 7340 Hypertape Drive

The IBM Hypertape Drive, Model 2, when used with the IBM 1401 and 1460 Data Processing Systems, makes it possible to read and write magnetic tape at speeds of 34,000 alphanumeric characters a second and 68,000 numeric characters a second. With this input/output magnetic-tape facility, data in the form of 8 data bits and 2 parity bits, is recorded at a density of 1,511 alphanumeric characters per inch. Where numeric packing is possible and is used, the recording density is 3,022 digits to the inch.

### Instructions

All operations performed by the IBM 7641 Hypertape Control Unit and the IBM 7340 Hypertape Drive, Model 2, result from four basic instructions: Read, Write, Control, and Sense.

READ and WRITE instructions initiate movement of data between the processing unit and the tape units.

The CONTROL instruction initiates the transfer of orders (as data) from the core-storage area to the control unit.

The SENSE instruction initiates the movement of status conditions (as data) from the control unit to core storage. After this status data is moved to the processor, it is tested by the stored program (some conditions require operator intervention). The SENSE instruction is used for detection of errors and unusual conditions.

### Start Control

*Instruction Format.*

Mnemonic	Op Code	d-character
SS	<u>K</u>	F

*Function.* The START CONTROL instruction (K with an F d-character) alerts the control unit that the following MOVE and LOAD instruction contains a control order

at the core-storage location specified in the B-address. When the MOVE or LOAD instruction is executed, the control order will be moved from core storage to the control unit. The control orders are transmitted as either two or three 4-bit characters. The first two characters indicate the operation code, and the third character indicates the address of the Hypertape Drive Unit (the third character is used for select only).

After the order is transmitted to the 7641, it is decoded and executed by the control unit. For complete description of hypertape control orders, refer to Figure 22.

*Word Marks.* Word marks are not affected.

*Timing.* Refer to Figure 22.

### Start Sense

*Instruction Format.*

Mnemonic	Op Code	d-character
SS	<u>K</u>	G

*Function.* The START SENSE instruction (K with a G d-character) alerts the control unit that the following MOVE or LOAD instruction will move status data from the 7641 to the core-storage position specified in the B-address. This data reflects the status of the control unit and the currently selected hypertape drive. These status conditions are set in the 7641 and are always available to the computer. The status indicators reflect error and other conditions that the computer should be aware of. The status indicators are retained by the 7641 until reset by the initiation of a subsequent read, write, or control operation.

The status data is in the form of seven 4-bit characters transmitted over the A, 4, 2, and 1 BCD bit lines. Transmission of data continues for seven char-

The control instruction (K Op Code, and an F d-character) is given to initiate a control operation. The MOVE or LOAD instruction will then move the control order numeric code from the computer to the control unit. The B-address of the MOVE and LOAD instruction specifies the core storage location where the control order is stored. The d-character of W (Write) is used because the transmission of data is from the computer to the control unit. If x in the numeric code is a group mark with a word mark, the system will terminate the transmission of control data and proceed with the next sequential instruction. Any other BCD code configuration in the x position will be ignored by the 7641 Control Unit; the system will not proceed to the next sequential instruction until the control unit signals an END condition.

INSTRUCTION		CONTROL ORDER	NUMERIC CODE	OPERATION	TK ms
Op code	A - address				
M or L	% 1 1	x x x	01 x	These control orders will condition the control unit to process tape in either the unpacked, packed, or 7074 packed mode. They will take precedent over the setting of the Tape Record Format Switch. Pressing the Start Reset Key on the system operating panel will return control to the switch.	.0575
		W	02 x		
		(B - address specifies high - order core Storage - position where numerical code for the particular control order is stored.)	03 x		
		Set 7074 Packed Mode	06 n	This order selects the addressed Drive and signals END to the system. The third character (n) is 0, 1, 2, or 3.	.065 ms
		Rewind	30 x	This order initiates a rewind operation for the selected Drive, signals END to the processing unit and places the Drive in busy status until rewind is completed. Operation is terminated when BOT marker is sensed. Attention is signaled to the computer upon successful completion of the operation.	3.06 ms
		Rewind Unload	31 x	This order first initiates a rewind operation for the selected Drive, and upon sensing the BOT marker, an unload operation is initiated. END is signaled to the system at the beginning of the rewind operation. Attention signaled upon successful completion.	3.06 ms
		Erase Long Gap	32 x	This order causes forward spacing and erases eight inches of tape for the selected Drive. END is signaled upon successful completion of the operation.	366.00 ms
		Write Tape Mark	33 x	This order causes the selected Drive to write a tape mark. Inter-record gaps precede and follow the tape mark record. END is signaled to the system upon successful completion of the operation.	23.8 ms
		Backspace	34 x	This order causes the selected Drive to backspace over one record. The END signal is sent to the computer upon successful completion of the operation.	$11.433 + (.0147 \times \text{number of characters in record}) \text{ ms}$
		Backspace File	35 x	This order causes the selected Drive to backspace over successive records until a tape mark is sensed. END is signaled to the computer upon completion of the operation. (Unusual End if BOT sensed.)	$11.785 + (11.179 \times \text{number of records}) + (.0147 \times \text{total number of characters in all records}) \text{ ms}$
		Space	36 x	This order causes the selected Drive to space forward over one record. END is signaled upon completion of the operation.	$16.41 + (.0294 \times \text{number of characters in record}) \text{ ms}$
		Space File	37 x	This order causes the selected Drive to space forward over successive records until a tape mark is sensed. END is signaled upon completion of the operation. (Unusual End if EOT sensed.)	$17.115 + (22.358 \times \text{no. of records}) + (.294 \times \text{total no. of char. in all records}) \text{ ms}$

Address Registers After Operation

I - address Reg. A - address Reg. B - address Reg.  
NS1 % 9 1 B + 4

Timing T = .161 ms (if x is group mark with a word mark)  
T = .1035 + TK ms (if x is BCD code configuration other than group mark - with a word mark) TK ms = Tape Control Unit Time

NOTE: For 1460 operation, subtract .0494 ms from both the .161 and the .1035 ms in timing formulas.

Figure 22. Control Operations

acters unless terminated by a stop from the computer. For a complete description of the sense status conditions, refer to Figures 23 and 24.

**Word Marks.** Word marks are not affected.

**Timing.** Refer to Figure 23.

**Start Read**

*Instruction Format.*

Mnemonic	Op Code	A-address	d-character
CU	<u>U</u>	%11	E

**Function.** The START READ instruction alerts the control unit that the following MOVE and LOAD instruction

The sense instruction (K OP code, and a G d-character) is given to initiate a sense operation. The MOVE or LOAD instruction will then move the status data from the control unit to the computer. The B-address of the MOVE and LOAD instruction specifies the core storage location where the first status character is stored. The d-character of R (Read) is used because the transmission of data is from the control unit to the computer.

INSTRUCTION				STATUS CHARACTERS	BCD BITS	INDICATION	COMMENTS
Op code	A-address	B-address	d-character				
<u>M</u> or <u>L</u>	% 1 1	x x x	R	1	A 4 2 1	* Operator Required * Program Check * Data Check * Exceptional Condition	Summary Character
(B-address specifies high order core storage position where first status character is stored. All seven status characters are sequentially transmitted to the processor, unless terminated by a stop from the computer.)				2	A 4 2 1	$\left. \begin{array}{c} 1 \\ - \\ 1 \\ - \end{array} \right\} 0 \quad \left. \begin{array}{c} - \\ - \\ - \\ 1 \end{array} \right\} 1 \quad \left. \begin{array}{c} - \\ - \\ 1 \\ - \end{array} \right\} 2 \quad \left. \begin{array}{c} - \\ - \\ 1 \\ 1 \end{array} \right\} 3$	Selected Tape Unit Address
				3	A 4 2 1	Selected Drive Not Ready	Operator Required
				4	A 4 2 1	Selected Drive Not Loaded Selected Drive File Protected Not Used	Program Check
				5	A 4 2 1	* Invalid Order Operation Code Selected Drive Busy Selected Drive at BOT Selected Drive at EOT	Data Check
				6	A 4 2 1	* Correction Occurred * Channel Parity Check * Code Check * Envelope Check	
				7	A 4 2 1	* Selected Drive Read a Tape Mark Selected Drive in EWA	Exceptional Condition
Address Registers After Operation				* Reset by Read, Write, or Control instruction			
I-address Reg. NSI	A-address Reg. % 9 1	B-address Reg. B+B					
Timing T = .2473 ms (When receiving seven status characters)							
NOTE: For 1460 operation, subtract .0494 ms from the .2473 ms in timing formula.							

Figure 23. Sense Operation

The summary status character is set if any of the status conditions are present. This character can be interrogated by the stored program; if no bits are set, interrogation of the remaining status characters is not necessary.

CHARACTER	BIT	CONDITION	COMMENTS
1 (Summary character)	A	Selected Drive not ready.	Operator required
	4	Selected Drive is not loaded. Selected Drive is file-protected and a WRITE instruction is given. Selected Drive is busy (Rewinding). Selected Drive is at BOT marker, and a backspace or backspace file order was given. Selected Drive is at EOT marker, and an order requiring forward motion was given. Invalid operation code.	Program check
	2	Multiple track check: this indicates more than one envelope check. Channel parity: parity error detected during transmission of data from processing unit to 7641. Code check: while reading, a malfunction occurred that produced an uncorrectable error. Envelope check: during a write operation, one or more bit tracks were in error. Overrun check: this indicates that the system failed to receive or transmit a character within the allotted time for normal character transmission. This error can occur after a read or write operation. Excessive skew: this indicates that the bits on tape do not fall within the Hypertape character-position limits. Track start check: this indicates a circuit failure in a bit track.	Data check
	1	Selected drive read a tape mark: indicates a tape mark was sensed while reading. Selected drive in EWA: indicates End Warning Area Marker is sensed when writing.	Exceptional condition

Figure 24. Summary Status Characters

will move data read from tape to core storage, starting with the position specified by the B-address.

The read operation is stopped by sensing an inter-record gap (IRG) on tape, or sensing a group-mark

with a word-mark in core storage. Refer to Figure 25 for detailed description of the read operation.

**Word Marks.** Word marks are not affected.

**Timing.** Refer to Figure 25.

INSTRUCTION				FUNCTION	OPERATION
Op code	A - address	B - address	d - character		
<u>U</u>	% I 1		E	Start Read	This instruction causes the selected Drive to physically start moving tape. The following MOVE or LOAD instruction must be given within 12 milliseconds after the actual movement of tape starts. If 12 milliseconds is exceeded, an overrun check condition may occur.
<u>M</u> or <u>L</u>	% I 1	x x x	R	Read Tape	This instruction causes the selected Drive to read tape and store the data in core storage starting at the location specified by the B-address. The B-address specifies the high-order position of the record. The read operation is terminated by sensing an inter-record gap on tape, or sensing a group-mark with a word-mark in core storage. In the unpacked mode if the <u>L</u> Op code is used, word marks on tape will be transferred to core storage.
Address Register After MOVE or LOAD Operation					
I - address Reg. NSI	A - address Reg. % 9 1	B - address Reg. Group - mark + 1			
Timing is computed from initiation of the Start Read instruction to the completion of the MOVE or LOAD instruction.					
Timing for unpacked tape: $T = 15.343 + (.0294 \times \text{number of characters in record}) \text{ ms}$ , if 1401 disconnects $T = 16.526 + (.0294 \times \text{number of characters in record}) \text{ ms}$ , if 7641 disconnects					
* Timing for packed numeric tape: $T = 15.343 + (.0147 \times \text{number of characters in record}) \text{ ms}$ , if 1401 disconnects $T = 16.526 + (.0147 \times \text{number of characters in record}) \text{ ms}$ , if 7641 disconnects					
* If combination of alphabetic and packed numeric tape is processed, the character rate of .0147 ranges from .0147 to .0294 ms.					
NOTE: If tape is at BOT, add 336 ms to timings in above formulas. For 1460 operation, subtract .033 ms from both the 15.343 ms and the 16.526 ms in timing formulas.					

Figure 25. Read Operation

INSTRUCTION				FUNCTION	OPERATION						
Op code	A-address	B-address	d-character								
<u>U</u>	% I 1		D	Start Write	This instruction causes the selected drive to physically start moving tape. The following MOVE or LOAD instruction must be given within 14 milliseconds after the actual movement of tape starts. If 14 milliseconds is exceeded, an overrun check condition may occur.						
<u>M</u> or <u>L</u>	% I 1	xxx	W	Write Tape	This instruction causes the selected drive to write tape starting from the core storage position specified by the B-address. The B-address specifies the high-order position of the record. The write operation is terminated by sensing a group-mark with a word-mark in core storage. In the unpacked mode if the L Op code is used, word marks will be written on tape.						
<p>Address Registers After MOVE or LOAD Operation</p> <table> <tr> <td>I-address Reg.</td> <td>A-address Reg.</td> <td>B-address Reg.</td> </tr> <tr> <td>NSI</td> <td>% 9 1</td> <td>Group-Mark + 1</td> </tr> </table> <p>Timing is computed from initiation of the Start Write instruction to the completion of the MOVE or LOAD instruction.</p> <p>Timing for unpacked tape. <math>T = 15.295 + (.0294 \times \text{number of characters in record}) \text{ ms}</math></p> <p>* Timing for packed numeric tape. <math>T = 15.295 + (.0147 \times \text{number of characters in record}) \text{ ms}</math></p> <p>* If combination of alphabetic and packed numeric tape is written, the character rate of .0147 ranges from .0147 to .0294 ms.</p> <p>NOTE: If tape is at BOT, add 336 ms to timings in above formulas. The END status conditions are not available until 7.873 ms after completion of the MOVE or LOAD operation. For 1460 operation, subtract .033 ms from the 15.295 ms in timing formula.</p>						I-address Reg.	A-address Reg.	B-address Reg.	NSI	% 9 1	Group-Mark + 1
I-address Reg.	A-address Reg.	B-address Reg.									
NSI	% 9 1	Group-Mark + 1									

Figure 26. Write Operation

### Start Write

#### Instruction Format.

Mnemonic	Op Code	A-address	d-character
CU	<u>U</u>	%I1	D

**Function.** The START WRITE instruction alerts the control unit that the following MOVE and LOAD instruction will move data from core storage, starting with the position specified by the B-address, to the control unit on the hypertape drive.

The write operation is stopped by sensing a group-mark with a word-mark in core storage. Refer to Figure 26 for detailed description of the write operation.

**Word Marks.** Word marks are not affected.

**Timing.** Refer to Figure 26.

### Branch if Indicator On

#### Instruction Format.

Mnemonic	Op Code	I-address	d-character
BIN	<u>B</u>	xxx	x

**Function.** The d-character in the BRANCH IF INDICATOR ON instruction specifies the indicator tested. If the indicator is ON, a branch to the specified I-address occurs. If the indicator is OFF, the next sequential instruction is taken. Figure 27 shows the instructions, d-characters, and the conditions tested.

**Word Marks.** Word marks are not affected.

**Timing.** Refer to Figure 27.

### Response

#### Instruction Format.

Mnemonic	Op Code	I-address	d-character
SSB	<u>K</u>	(xxx)	x

**Function.** This RESPONSE instruction resets the Attention indicator if ON with a B d-character and resets the End indicators if ON with E d-character.

The K(xxx) E instruction must be executed before another hypertape operation is initiated. Refer to Figure 27 for detail information.

**Word Marks.** Word marks are not affected.

**Timing.** Refer to Figure 27.

INSTRUCTION			CONDITION
Op code	I-address	d-Character	
<u>B</u>	xxx	1	Test for Unusual End. This indicator is set ON if any unusual condition occurs such as selected drive not ready, busy, not loaded, file protected (if write instruction given), at BOT, at EOT, in end warning area, read a tape mark, read and write errors. (See Note)
<u>B</u>	xxx	2	Test for Normal End. This indicator is set ON if the operation has been successfully completed as instructed and no unusual conditions occurred. (See Note)
<u>B</u>	xxx	3	Test for 7641 Busy. This indicator is set ON if the 7641 Control Unit is busy. This instruction should be given before a read, write, control, or sense instruction to make sure the control is not busy, and should be given again after these instructions are given to make sure the 7641 has become busy.
<u>B</u>	xxx	4	Test for Attention. This indicator is set ON when the selected drive has completed a rewind operation and is now in a Ready Status, or if the drive has been put in a Ready Status manually.
<u>K</u>	(xxx)	B	Attention Response. This instruction resets the Attention indicator if on.
<u>K</u>	(xxx)	E	End Response. This instruction resets the End or Unusual End indicators if on. (See Note)
Address Register After Operation			
I-address Reg.	A-address Reg.	B-address Reg.	
NSI	BI	BI	( <u>B</u> (III) d instruction)
NSI	BI	dbi	( <u>K</u> (III) d instruction)
Timing T = .0115(L <sub>1</sub> + 1) ms (For 1460 operation replace .0115 ms with .006 ms)			
NOTE: A branch on either <u>B</u> (III) 1 or <u>B</u> (III) 2 must be successful prior to initiating the <u>K</u> (xxx) instruction. The <u>K</u> (xxx) E instruction <u>must</u> be executed before initiating another Hypertape operation.			

Figure 27. Branch-If-Indicator On and Response

# IBM 1011 Paper Tape Reader

The IBM 1011 Paper Tape Reader for the IBM 1401, 1410, 1440, and 1460 Data Processing Systems is an input device controlled by stored programs in the same manner as other input-output equipment (card reader, card punch, and printer).

Information punched in paper tape can be read by the IBM 1011 directly into any area of 1401, 1440, or 1460 core storage. Any character punched in 5-track telegraphic, 8-track IBM, or many other paper-tape codes can be encoded into any valid 1401/1440/1460 character through the flexibility of control-panel wiring on the tape reader.

## Instructions

The instructions described in this section are for the IBM 1401, 1440, and 1460 Data Processing Systems.

### Read from Paper Tape

#### Instruction Format.

Op Code <u>M</u>	A-address %P1	B-address BBB	d-character R
---------------------	------------------	------------------	------------------

**Function.** This instruction causes data to be read from the paper tape reader into core storage, beginning at the B-address.

The M Op code specifies that the operation will be performed in the *move* mode. When the M operation code is used, word marks are not transferred into core storage with the data read from the paper tape, and word marks in the core-storage paper-tape read-in areas are undisturbed. The A-address, %P1, is the code assigned to both the IBM 1011 Paper Tape Reader and the IBM 1012 Tape Punch.

The B-address specifies the core-storage position (high-order) that receives the first character of information from the paper-tape reader. The succeeding characters are read into the adjacent higher-numbered core-storage positions.

The d-character R specifies a read operation. The read operation ends either by detection of a group-mark with a word-mark in core storage (signifies the end of the read-in area), or by reading an EOR (end-of-record character) character punched in the tape.

Any paper-tape character can be used as an end-of-record character. Wiring the assigned end-of-record character decode-exit hub to the end-of-record IN hub terminates the paper-tape read operation and enters a group mark in core storage.

**Note.** If a group-mark with a word-mark in core storage is used to terminate the paper-tape-read operation, the character read into the A-register, when the group-mark with a word-mark is sensed, will be lost.

**Word Marks.** Word marks are not affected.

**Timing** ( $T = N(L_1 + 1)$  ms + record transmission time.  
 $N = .0115$  (1401),  $.0111$  (1440),  $.006$  (1460).

#### Address Registers After Operation.

I-Add. Reg. NSI	A-Add. Reg. %71	B-Add. Reg. B + message length + 1
--------------------	--------------------	---------------------------------------

### Read from Paper Tape with Word Marks

#### Instruction Format.

Op Code <u>L</u>	A-address %P1	B-address BBB	d-character R
---------------------	------------------	------------------	------------------

**Function.** This instruction is similar to the **READ FROM PAPER TAPE** instruction, except that word marks are removed from the paper-tape read-in area in core storage, and word-separator characters read from the paper-tape reader causes the insertion of a word mark in core storage with the next character read from the 1011. The L Op code specifies that the operation will be performed in the load mode, which results in the word mark control already discussed.

**Word Marks.** Word marks are removed from the paper-tape read-in area in core storage, and word-separator characters read from the paper-tape reader causes a word mark to be associated with the next character read from the 1011.

**Timing.**  $T = N(L_1 + 1)$  ms + record transmission time.

#### Address Registers After Operation.

I-Add. Reg. NSI	A-Add. Reg. %71	B-Add. Reg. B + message length + 1
--------------------	--------------------	---------------------------------------



### Branch if Input/Output Indicator On

#### Instruction Format.

Op Code	I-address	d-character
<u>B</u>	III	1

**Function.** When a parity error is detected during a read operation, the PE hub provides an error output (8-track tape only). When the error condition occurs, the error character is suppressed and a special output is made available on the paper-tape-reader control panel. This signal can be used to either substitute a unique error character, or delete that position. Refer to CONTROL and SPECIAL PURPOSE hubs in *IBM 1011 Paper Tape Reader*, Form A26-5754.

The detected parity error also turns on the input-output error latch in the system. A paper-tape-read operation should always be followed by a BRANCH IF INPUT-OUTPUT INDICATOR ON instruction. This instruction checks the status of the input-output error latch. If the latch is ON, the system branches to the error subroutine. If the latch is OFF, the program goes to the next sequential instruction.

**Word Marks.** Word marks are not affected.

#### Timing.

No Branch:

$$T = N (L_I + 1) \text{ ms.}$$

Branch (without indexing):

$$T = N (L_I + 1) \text{ ms.}$$

Branch (with indexing):

$$T = N (L_I + 2) \text{ ms.}$$

#### Address Registers After Operation.

	I-Add. Reg.	A-Add. Reg.	B-Add. Reg.
No Branch (no indexing)	NSI	BI	dbb
Branch (no indexing)	NSI	BI	Blank
Branch (with indexing)	NSI	BI	NSI

### Branch if Paper Tape Reader Ready

#### Instruction Format.

Op Code	I-address	d-character
<u>B</u>	III	2

**Function.** This instruction checks the status of the tape-reader-ready indicator. If the paper-tape reader is not ready, when tested, the program goes to the next sequential instruction. If the paper-tape reader is ready, when tested, the program branches to the subroutine that begins at the core-storage position specified by the instruction I-address.

**Word Marks.** Word marks are not affected.

#### Timing.

No Branch:

$$T = N (L_I + 1) \text{ ms.}$$

Branch (without indexing):

$$T = N (L_I + 1) \text{ ms.}$$

Branch (with indexing):

$$T = N (L_I + 2) \text{ ms.}$$

#### Address Registers After Operation.

	I-Add. Reg.	A-Add. Reg.	B-Add. Reg.
No Branch (no indexing)	NSI	BI	dbb
Branch (no indexing)	NSI	BI	Blank
Branch (with indexing)	NSI	BI	NSI

# IBM 1012 Tape Punch

The IBM 1012 Tape Punch attached to the IBM 1401, 1440, or 1460 Data Processing Systems is an output device controlled by stored programs in the same manner as other input-output equipment (card reader, card punch, and printer).

The IBM 1012 Tape Punch operates at the rate of 150 tape characters per second, using 5-, 6-, 7-, or 8-track paper tape, supplied from a reel. Data, stored in the core-storage area of 1401, 1440, or 1460 systems and ready to be punched, is converted to the appropriate tape code by using a translation program that includes the appropriate stored code table.

## Instructions

The instructions described in this section are for the 1401, 1440, and 1460 operating with the IBM 1012 Tape Punch.

### Write on Tape Punch

#### Instruction Format.

Op Code	A-address	B-address	d-character
<u>M</u>	%P1	BBB	W

**Function.** This instruction causes one vertical tape column to be punched. The M Op code specifies an operation in the move mode. When the M operation code is used, word marks are not transferred from core storage to the tape punch. The A-address, %P1, is the code assigned to both the IBM 1011 Paper Tape Reader and the IBM 1012 Tape Punch.

The B-address specifies the first core-storage position (high-order) of the three-position field. The three-position field contains the total bit configuration that will be punched in one vertical column in the tape. The d-character W specifies a write operation.

**Word Marks.** Word marks are not affected.

**Timing.**  $T = N(L_1 + 1)$  ms + transmission time.

$N = .0115$  (1401),  $.0111$  (1440),  $.006$  (1460).

### Address Registers After Operation.

I-Add. Reg.	A-Add. Reg.	B-Add. Reg.
NSI	%71	B + 3

### Tape Punch Read Back Check

#### Instruction Format.

Op Code	A-address	B-address	d-character
<u>M</u>	%P1	BBB	R

**Function.** This instruction reads one vertical tape column when a read back check is desired on the characters punched in the tape. The M Op code specifies an operation in the move mode. When the M operation code is used, word marks in core storage are not removed or affected. The A-address, %P1, is the code assigned to both the IBM 1011 Paper Tape Reader and the IBM 1012 Tape Punch.

The B-address specifies the first core-storage position (high-order) of the three-position field. The three-position field contains the total bit configuration of the character being read from the tape at the reading station. The d-character R specifies a read operation.

**Word Marks.** Word marks are not affected.

**Timing.**  $T = N(L_1 + 1)$  ms + transmission time.

### Address Registers After Operation.

I-Add. Reg.	A-Add. Reg.	B-Add. Reg.
NSI	%71	B + 3

### Backspace Tape

#### Instruction Format.

Op Code	d-character
<u>K</u>	A

**Function.** This instruction moves the tape backward one vertical column. The program then goes to the next sequential instruction.

**Word Marks.** Word marks are not affected.

**Timing.**  $T = N(L_1 + 1)$  ms.

### Address Registers After Operation.

I-Add. Reg.	A-Add. Reg.	B-Add. Reg.
NSI	dbb	dbb

### Backspace Tape and Branch

#### Instruction Format.

Op Code	I-address	d-character
<u>K</u>	III	A

**Function.** This instruction is similar to the BACKSPACE TAPE instruction, except that the location of the next instruction is taken from the I-address.

**Word Marks.** Word marks are not affected.

**Timing.**  $T = N(L_I + 1)$  ms.

#### Address Registers After Operation.

I-Add. Reg.	A-Add. Reg.	B-Add. Reg.
NSI	BI	dbb

### Branch if in Backspace Operation

#### Instruction Format.

Op Code	I-address	d-character
<u>B</u>	III	1

**Function.** This instruction checks to see whether the tape punch is executing a backspace operation. The backspace operation condition is present from the time the tape punch is signaled to execute the backspace operation until the operation is completed.

If a backspace operation is in progress, when checked, the program branches to the subroutine that starts at the I-address specified in the instruction. If a backspace operation is not in process, when checked, the program goes to the next sequential instruction.

**Word Marks.** Word marks are not affected.

#### Timing.

No Branch:

$$T = N(L_I + 1) \text{ ms.}$$

Branch (without indexing):

$$T = N(L_I + 1) \text{ ms.}$$

Branch (with indexing):

$$T = N(L_I + 2) \text{ ms.}$$

#### Address Registers After Operation.

	I-Add. Reg.	A-Add. Reg.	B-Add. Reg.
No Branch (no indexing)	NSI	BI	dbb
Branch (no indexing)	NSI	BI	Blank
Branch (with indexing)	NSI	BI	NSI

### Branch if Tape Punch Ready

#### Instruction Format.

Op Code	I-address	d-character
<u>B</u>	III	2

**Function.** This instruction checks to see whether the tape punch is in a ready condition. The tape punch is considered in a ready condition when each of the following conditions is satisfied:

1. Tape properly loaded
2. Tape tension is normal
3. Electrical power is supplied
4. Start switch has been pressed.

If the tape punch is in a ready condition, when checked, the program branches to the subroutine that starts at the I-address specified in the instruction. If the tape punch is not in a ready condition, when checked, the program goes to the next sequential instruction.

**Word Marks.** Word marks are not affected.

#### Timing.

No Branch:

$$T = N(L_I + 1) \text{ ms.}$$

Branch (without indexing):

$$T = N(L_I + 1) \text{ ms.}$$

Branch (with indexing):

$$T = N(L_I + 2) \text{ ms.}$$

#### Address Registers After Operation.

	I-Add. Reg.	A-Add. Reg.	B-Add. Reg.
No Branch (no indexing)	NSI	BI	dbb
Branch (no indexing)	NSI	BI	Blank
Branch (with indexing)	NSI	BI	NSI

### Branch if Tape Punch Not Ready to Accept Data

#### Instruction Format.

Op Code	I-address	d-character
<u>B</u>	III	3

**Function.** This instruction checks to see whether the tape punch is in the correct mechanical position to accept data. The IBM 1012 Tape Punch punches tape at the speed of 150 characters per second (6.6 milliseconds between characters). The data can be accepted during a 1.5-millisecond (ms) portion of the 6.6 ms time interval between characters.

If the tape punch is not in correct mechanical position to accept data, when checked, the program branches to the subroutine that starts at the I-address specified in the instruction. If the tape punch is in correct mechanical position to accept data, the program goes to the next sequential instruction.

**Word Marks.** Word marks are not affected.

**Timing.**

No Branch:

$$T = N (L_I + 1) \text{ ms.}$$

Branch (without indexing):

$$T = N (L_I + 1) \text{ ms.}$$

Branch (with indexing):

$$T = N (L_I + 2) \text{ ms.}$$

**Address Registers After Operation.**

	<i>I-Add. Reg.</i>	<i>A-Add. Reg.</i>	<i>B-Add. Reg.</i>
No Branch (no indexing)	NSI	BI	dbb
Branch (no indexing)	NSI	BI	Blank
Branch (with indexing)	NSI	BI	NSI

**Branch if Tape Punch is Not Ready to Read**

**Instruction Format.**

<i>Op Code</i>	<i>I-address</i>	<i>d-character</i>
<u>B</u>	III	4

**Function.** This instruction checks to see whether the reading portion of a punch cycle has been reached. The IBM 1012 Tape Punch punches tape at the speed of 150 characters per second (6.6 milliseconds between characters). A 1.8-millisecond (ms) portion of the 6.6 ms time interval between characters is reserved for the actual read operation.

If the reading portion of a punch cycle has not been reached, when checked, the program branches to the subroutine that starts at the I-address specified in the instruction. If the reading portion of a punch cycle has been reached, the program goes to the next sequential instruction.

**Word Marks.** Word marks are not affected.

**Timing.**

No Branch:

$$T = N (L_I + 1) \text{ ms.}$$

Branch (without indexing):

$$T = N (L_I + 1) \text{ ms.}$$

Branch (with indexing):

$$T = N (L_I + 2) \text{ ms.}$$

**Address Registers After Operation.**

	<i>I-Add. Reg.</i>	<i>A-Add. Reg.</i>	<i>B-Add. Reg.</i>
No Branch (no indexing)	NSI	BI	dbb
Branch (no indexing)	NSI	BI	Blank
Branch (with indexing)	NSI	BI	NSI

**Branch if Tape Punch Overextended**

**Instruction Format.**

<i>Op Code</i>	<i>I-address</i>	<i>d-character</i>
<u>B</u>	III	5

**Function.** This instruction checks to see whether a previous punch (or read) operation occurred within the allotted time during the last possible punch (or read) cycle.

If a punch (or read) operation did not occur within the allotted time, it usually indicates a machine malfunction, and the tape punch can be stopped through programming. This condition:

1. Always exists when the tape punch is idle
2. Exists until a punch (or read) operation starts
3. Never exists when the tape punch is punching (or reading) at its maximum speed.

If a punch (or read) operation did not occur within the allotted time, when checked, the program branches to the subroutine that starts at the I-address specified in the instruction. If a punch (or read) operation did occur within the allotted time, when checked, the program goes to the next sequential instruction.

**Word Marks.** Word marks are not affected.

**Timing.**

No Branch:

$$T = N (L_I + 1) \text{ ms.}$$

Branch (without indexing):

$$T = N (L_I + 1) \text{ ms.}$$

Branch (with indexing):

$$T = N (L_I + 2) \text{ ms.}$$

**Address Registers After Operation.**

	<i>I-Add. Reg.</i>	<i>A-Add. Reg.</i>	<i>B-Add. Reg.</i>
No Branch (no indexing)	NSI	BI	dbb
Branch (no indexing)	NSI	BI	Blank
Branch (with indexing)	NSI	BI	NSI

## Branch if Supply Reel Low or Chad Box Full

### Instruction Format.

Op Code	I-address	d-character
<u>B</u>	III	6

**Function.** This instruction checks to see whether either an end-of-reel (supply reel low) condition exists or the chad box is full or not in position. Additional punching can occur after the supply-reel-low condition occurs, but the amount of additional punching depends upon the length of the records being punched.

If the supply reel is low, or the chad box is full or not in position, when checked, the program branches to the subroutine that starts at the I-address specified in the instruction. Otherwise, the program goes to the next sequential instruction.

**Word Marks.** Word marks are not affected.

### Timing.

No Branch:

$$T = N (L_1 + 1) \text{ ms.}$$

Branch (without indexing):

$$T = N (L_1 + 1) \text{ ms.}$$

Branch (with indexing):

$$T = N (L_1 + 2) \text{ ms.}$$

### Address Registers After Operation.

	I-Add. Reg.	A-Add. Reg.	B-Add. Reg.
No Branch (no indexing)	NSI	BI	dbb
Branch (no indexing)	NSI	BI	Blank
Branch (with indexing)	NSI	BI	NSI

## IBM 1012 Programming Concepts

The basic logic of programmed translation is based on a programming device known as *character selection*. Character selection uses a stored table to translate the system characters to the pattern required by the IBM 1012 Tape Punch. This method of translation makes a control panel unnecessary.

A stored-program routine controls the over-all operation of the 1012. PTAPE (punch tape), a macro instruction, will be provided in the *Autocoder* library of routines. The operand of the PTAPE command is the symbolic name of the output area to be punched. A second operand is used to designate whether the routine is to punch standard teletype (5-track) code or IBM standard (8-track) code. Therefore, when punching is desired, the programmer need merely write PTAPE with the appropriate operand(s). The *Autocoder* Processor then generates the necessary instructions to punch the tape.

The programs used for 6- and 7-track operation are basically the same as those used for 5- and 8-track operation. The major difference is in the stored table used for translating the system BCD codes into punch codes.

Once the theory of operation and the 5- and 8-track programs are understood, altering the program and the stored table is a simple task.

The decoding routine is within the 6.6-millisecond time interval between characters in the record that are to be punched. No attempt is made to overlap this time with the user's program. A special test is made for the 5-track tape to automatically generate mode-change characters where appropriate.

A brief description of the theory of operation is given to aid the user in understanding the over-all operation of the IBM 1012 Tape Punch. The examples used are not necessarily the only methods of programming the various operations. The examples are used primarily as an aid in simplifying the explanations. The methods, constants, and stored code tables used in the following explanations do not necessarily represent these items as they will appear in the macro instruction *PTAPE*.

The theory of operations (8-track operation) is explained in the following order:

1. Move character from record into test location
2. Decode to a table address
3. Get table argument for punching
4. Punch character in tape
5. Read-check
6. End-of-Record routine
7. Automatic error correction
8. End-of-Reel routine
9. Five-track tape operation.

### 1. Move Character from Record into Test Location

The record to be punched in tape can be any length (within the limits of available core storage) and may be stored in any system core-storage location. When a new record is ready to be punched into tape, a three-position field (the record address), is initialized to the first (high-order) position of the record. This field is moved to the A-address of a move instruction which, when executed, moves the first record character to a location in core storage where it can be analyzed. A character compare instruction then checks the character for an end-of-record indication. An equal compare causes a branch to the end-of-record routine; otherwise the program advances to the decode routine.

## 2. Decode to a Table Address

A table address (Figure 28) is developed for every character in the record. After the character is moved from the record into another core-storage location, it is analyzed to develop the table address. This is accomplished in the following manner.

Table Address	1401 Code					1401 Char	Card Code
	B	A	8	4	2		
0-2	X	X				&	12
3-5	X	X					
6-8	X	X					
9-11	X	X	X	X	X	.	12-3-8
12-14	X	X	X	X	X	□	12-4-8
15-17	X	X	X	X	X	[	12-5-8
18-20	X	X	X	X	X	<	12-6-8
21-23	X	X	X	X	X	#	12-7-8
24-26							
27-29							
30-32	X					-	11
33-35							
36-38							
39-41	X	X		X	X	\$	11-3-8
42-44	X	X	X			*	11-4-8
45-47	X	X	X	X	X	]	11-5-8
48-50	X	X	X	X	X	;	11-6-8
51-53	X	X	X	X	X	Δ	11-7-8
54-56							
57-59							
60-62	X					6	2-8
63-65							
66-68							
69-71	X	X	X	X	X	,	0-3-8
72-74	X	X	X	X	X	%	0-4-8
75-77	X	X	X	X	X	v	0-5-8
78-80	X	X	X	X	X	/	0-6-8
81-83	X	X	X	X	X	#	0-7-8
84-86							
87-89							
90-92						B L	No Punch
93-95							
96-98							
99-101	X	X	X			#	3-8
102-104	X	X				@	4-8
105-107	X	X	X			:	5-8
108-110	X	X	X	X		>	6-8
111-113	X	X	X	X	X	√	7-8
114-116							
117-119							

\*Not Used

Figure 28. Table Address Chart

A constant is moved to the A-address of a MOVE instruction. The constant would be the starting location of the table plus two. Assume the stored table starts in location 400. The constant used would be 402. The character to be punched is now analyzed to develop a table address. If the character contains a B-bit only, the constant 30 is added to the number (402) already in the A-address of the MOVE instruction. An A-bit, only, adds the constant 60, no zone-bits adds the constant 90; and if the character contains A- and B-bits, nothing is added. A further test determines whether the character is a special character or blank. The constant 120 is also added to the A-address of the MOVE instruction if the character is *not* a blank or special character. Furthermore, the sum of the digit bits in the character being analyzed is tripled and also added to the number already developed. As an example, assume the character

B (BA2) is being analyzed. The presence of an A- and B-bit would add nothing; however, 120 would be added because B is not a special character. The 2 bit is tripled, adding 6 to the number. The table address developed would therefore be 402 plus 120, plus 6, or a total of 528.

Figure 29 illustrates the arrangement of the characters in the table, and the bit pattern for punching that is contained in each 3-position character location. Assuming the starting location of the table is 400, the address 528 would direct the system to the low-order position of the 3-position location for the character B.

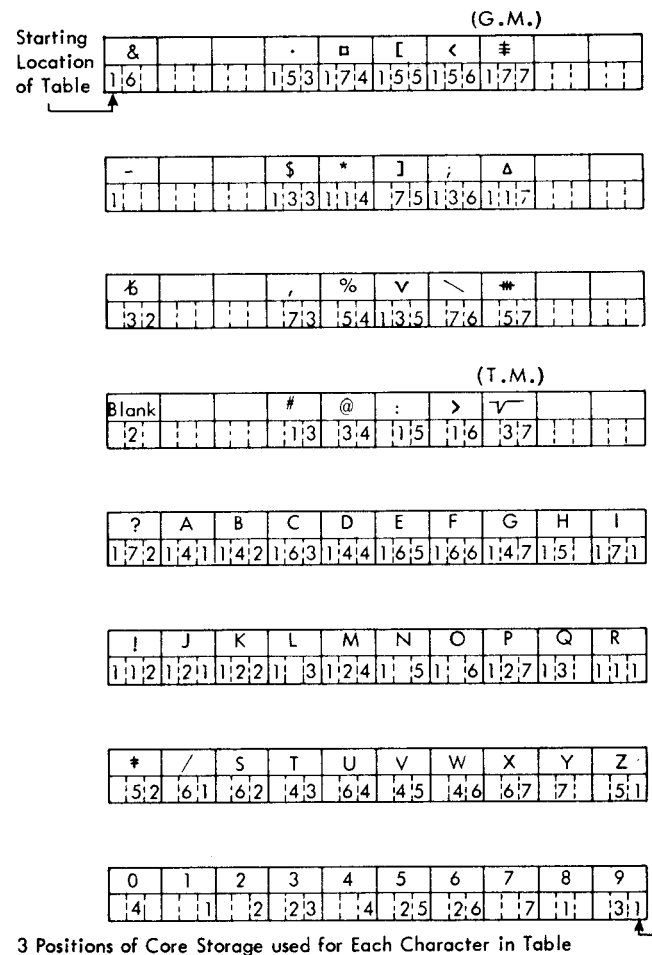

Figure 29. IBM Eight-Track Code Table

## 3. Get Table Argument for Punching

The table address for the character to be punched is developed in the A-address location of a MOVE instruction. The MOVE instruction, when executed, moves the proper field from the table and places it in an unused 3-position storage location referred to as QD. The character is now ready for punching using the bit pattern in location QD.

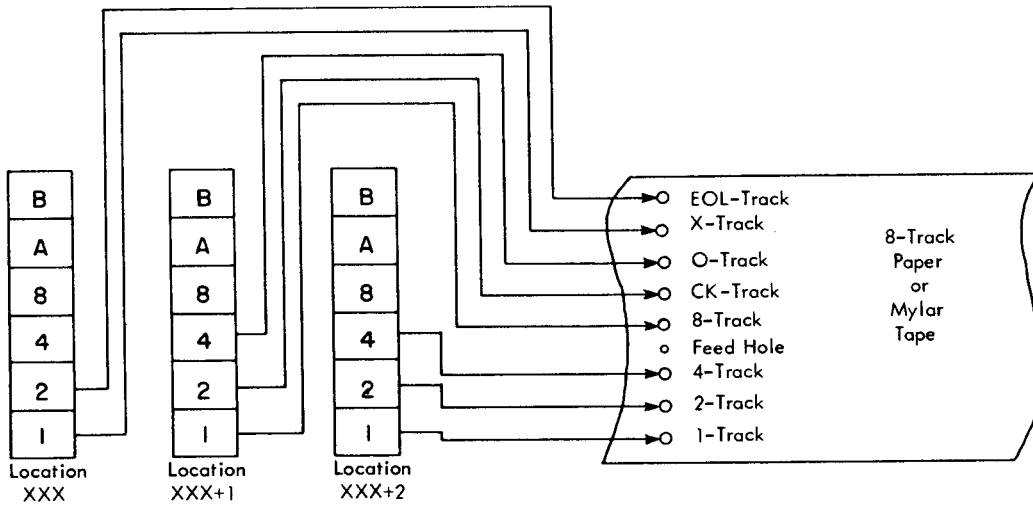

Figure 30. Eight-Track Bit Pattern to Tape Punching Translation

#### 4. Punch Character in Tape

The punch instruction  $M(\%P1)(BBB)W$  is executed next, which causes data to be transferred to the 1012 for punching. The address in the punch instruction refers to the high-order position of the three-position field (QD) that contains the bit pattern to punch one vertical column in the tape.

Figure 30 illustrates the bit pattern to tape-punching translation.

#### 5. Read-Check

Because of the delay between punching and reading, the punching bit pattern for four characters must be retained for checking. Four consecutive three-position fields are set aside for this purpose, as shown in Figure 5 of the *IBM 1012 Tape Punch, Form D24-1077*.

As noted in the punch routine, the bit pattern to be punched is moved from the stored table into location

QD. By a method described later, the character bit pattern for the column of the tape that can be read during this punch cycle is put in location QA.

The read instruction  $M(\%P1)(BBB)R$  causes data to be transferred from the reading station into three consecutive core-storage locations beginning in (BBB). The data transfer is in accordance to the pattern shown in Figure 31. This is similar to the punch transfer but with direction reversed. The three-position field into which data is read is compared to the contents of location QA. Thus, the punched tape is given a bit-by-bit comparison check. If punching and reading were correct, the *BRANCH COMPARE* instruction would not cause a branch to the error routine, but would continue to the next sequential instruction. After a valid compare, the contents of the four fields (QD, QC, QB, and QA) are shifted in preparation for the next read-check instruction. The program is then directed to the beginning to process the next character in the record.

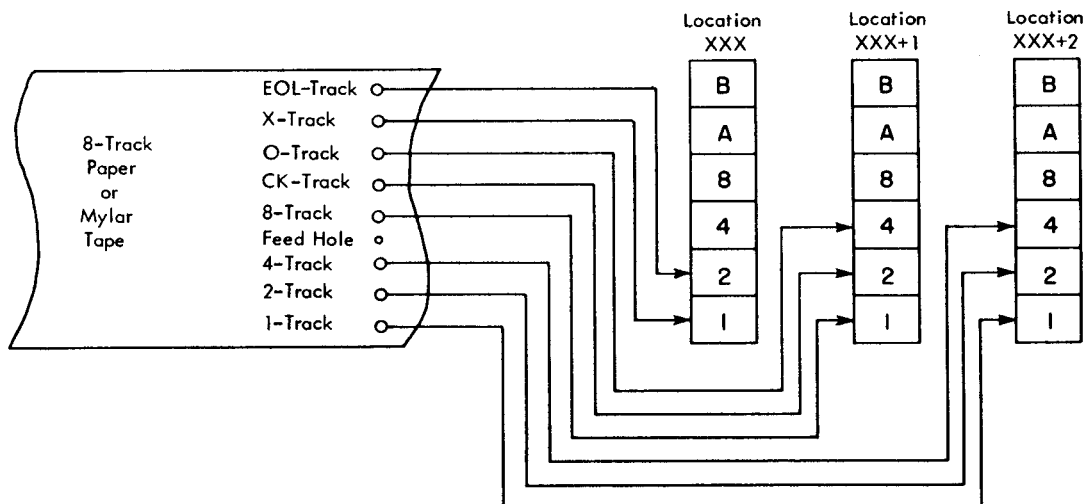

Figure 31. Eight-Track Tape Punching to Bit-Pattern Translation





tion. When an error is detected, the tape is backspaced until the character in error is under the punch station. The tape is then moved in a forward direction and four delete codes (all tracks punched except EOL) are punched. The constant 177 is the bit pattern for punching all tracks in the tape, except EOL. The delete codes that are punched are also read back and checked. A valid EOL may be encountered when the delete codes are checked (a hole punched in all tracks). This condition is recognized by the program routine, but no action is taken. When the tape is read later as an input to another system, this condition (even parity) signals an error. However, control-panel wiring or a program subroutine can be used to circumvent this condition. If an unequal compare (except EOL) is detected when the delete codes are checked, the error is corrected by branching to the normal error-correction routine.

After the delete codes have been punched, the characters that were deleted are now repunched. These characters are still in locations QD, QC, QB, and QA. These characters are punched starting with QA through QD.

### 8. End-of-Reel Routine

An end-of-reel test is made after every end-of-record program routine has been completed. After EOL has been punched (EOR), an appropriate end-of-file character (if required) can be punched in the tape. The last character in the record, EOL, and the end-of-file character (if required), are read back and checked before the end-of-reel program routine is completed.

After a new reel of tape has been installed, pressing the feed switch on the 1012 causes delete codes to be punched in the leader portion of the tape. Pressing the start key on the 1012 places the 1012 in a ready status. The last two delete codes punched in the leader portion of the tape are read and checked when the first record is punched in the new reel of tape.

### 9. Five-Track Tape Operation

Basically 5-track tape operation is similar to 8-track tape operation, with a limited number of exceptions. Only fifty-eight characters are punched when using 5-track tape, which necessitates the use of a different code table (Figure 33). To properly identify a charac-

Starting Location of Table

&		.	□	(	<	≠			
-1:3		-1:7	-2:3:6	(Blank)					

Carriage Return

3 Positions of Core Storage used for Each Character in Table

-		\$	*	)	.	Δ			
-3:1		-2:2	&3:7	-1:1	-1:7				

Letters Shift

ç		,	%	=	'	"			
		-1:6	-3:3		-3:2				

Figures Shift

Blank		#	@	:	>	√			
-1:4		-1:5	-1:1	-1:6	-2:1				

Line Feed

? (0)	A	B	C	D	E	F	G	H	I
-2:3 &3:3	&2:3	&1:6	&2:2	&2:2	&2:6	&1:3	&5	&1:4	

! (0)	J	K	L	M	N	O	P	Q	R
-2:6	&3:2	&3:6	&1:1	&7	&6	&3	&1:5	&3:5	&1:2

*	/	S	T	U	V	W	X	Y	Z
-2:4	-2:7	&2:4	&1:1	&3:4	&1:7	&3:1	&2:7	&2:5	&2:1

0	1	2	3	4	5	6	7	8	9
-1:5	-3:5	-3:1	-2:1	-1:2	-1:1	-2:5	-3:4	-1:4	-1:3

Last Location in Table

Figure 33. Five-Track Code Table

ter punched in the tape, a figures-shift or letters-shift code must precede the punched character, if a mode change takes place.

Development of the stored-table address (see Figure 28) remains the same as for 8-track operation (described in *Decode to a Table Address* section). The code number assigned to each character in the stored table differs from the code assigned to each character in the 8-track code table.

Figure 33 illustrates the code assigned to each of the fifty-eight characters in the stored table. Only two positions of each three-position field are used for the bit pattern of the code number. The high-order position of the three-position field contains a Dash (B-bit), or Ampersand (A- and B-bits). The dash signifies a figures-shift character, and the ampersand signifies a letters-shift character. After the table address has been developed for a character to be punched, the contents of the three-position table location are moved into location QD. The high-order position of QD is analyzed to determine whether the character is a figures-shift, or letters-shift character. After the mode of the character has been established, it is compared with the mode the 1012 is presently in. If a figures-shift character is to be punched and the 1012 is in a letters-shift mode, a change in mode is required. If a letters-shift character is to be punched and the 1012 is presently in figures-shift, a change in mode is required.

If a change in mode is required, one of two constants is moved into location QD. The constant is 33 if a change to figures-shift is required, or 37 if a change to letters-shift is required. These constants, when decoded (Figure 34), punch either a figures-shift or letters-shift code in the tape. The character to be punched is then moved back into location QD and punched. If a mode change is not required, punching takes place from QD without moving the constants. When a mode change is executed, it is retained to identify what mode the 1012 is presently in.

When a read-check instruction is executed, the high-order position of location QA is not involved in the comparison. However, if an error is detected, the bits in the high-order position of QA indicate the shift of the character when it is repunched. Figure 35 illustrates the 5-track tape punching to bit-pattern translation.

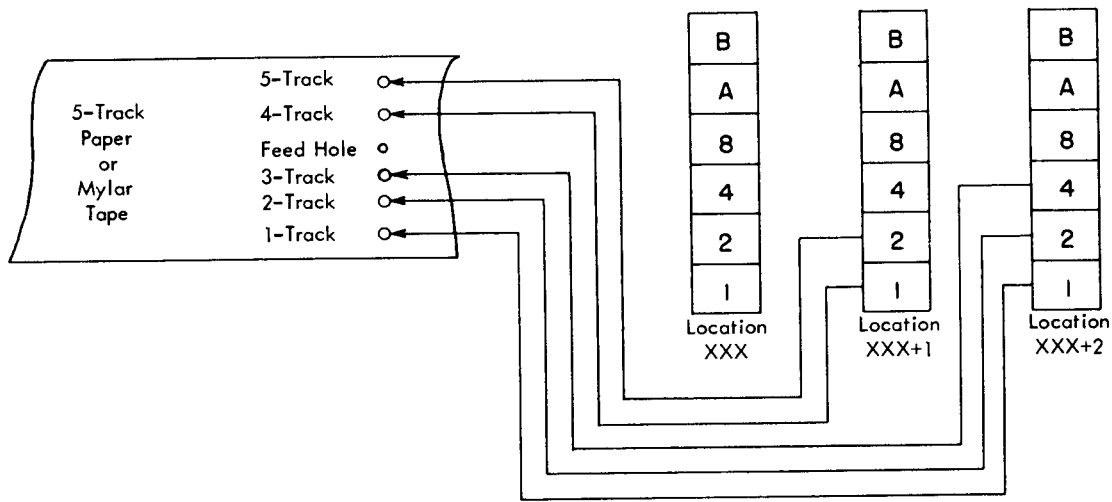

Figure 34. Five-Track Bit Pattern to Tape Punching Translation

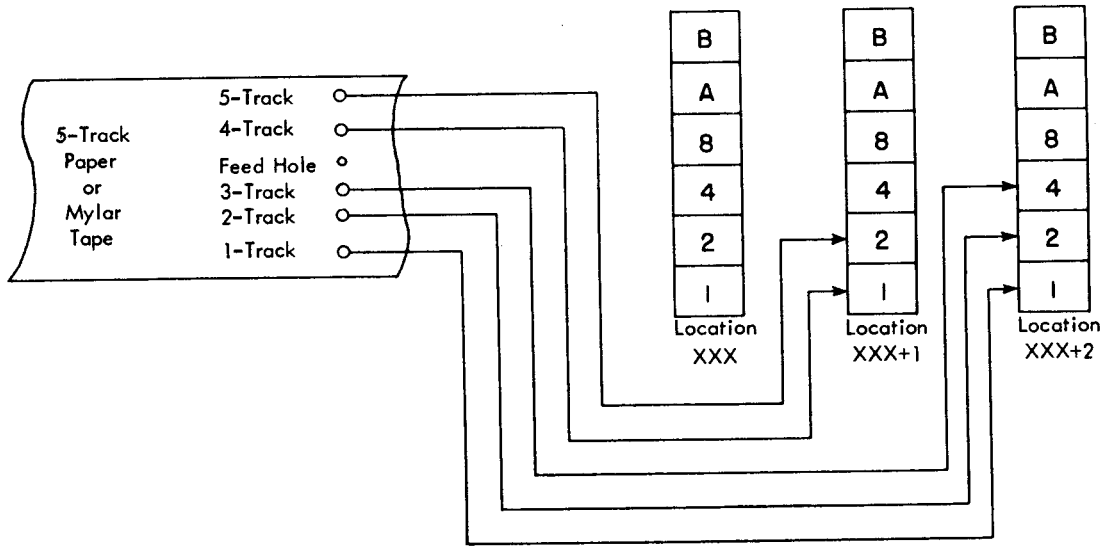

Figure 35. Five-Track Tape Punching to Bit-Pattern Translation

## IBM 7335 Magnetic Tape Unit, Models 1 and 2

An additional storage medium with the advantage of compact record handling is now available to the 1440 system user by attaching the IBM 7335 Magnetic Tape Unit Models 1 and 2 (Figure 36) to his 1440 system.

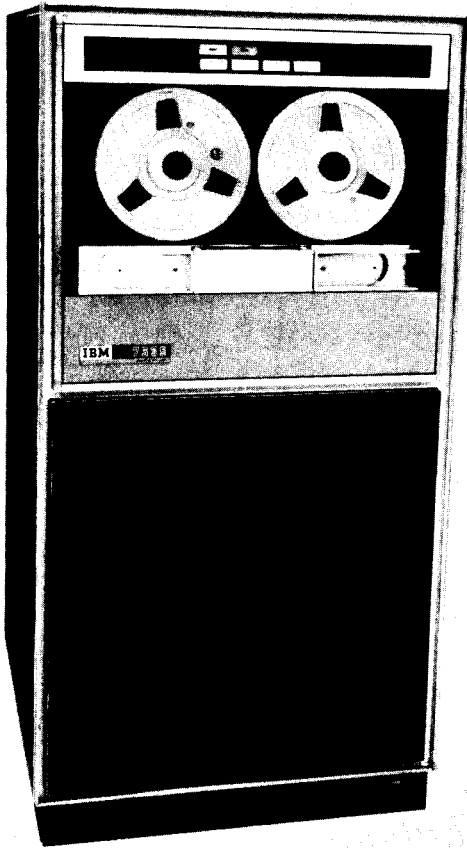

Figure 36. IBM 7335 Magnetic Tape Unit (Model 1)

The 7335 Magnetic Tape Unit characteristics are shown in Figure 37.

Data Rate	20,000 characters per second (CPS)
Bit Density	556 per inch (CPI)
Tape Speed	36 inches per second
Interrecord Gap	3/4 inch
Rewind (High Speed)	2.2 minutes

Figure 37. IBM 7335 Magnetic Tape Unit Characteristics

### Data Flow

The IBM 7335 Magnetic Tape Unit functions as both an input and an output device. The 7335 transports the tape and accomplishes the actual reading and writing of information as directed by outside control from the system's stored program.

### Magnetic-Tape Instructions

#### Read Tape

*Instruction Format.*

Mnemonic	Op Code	A-address	B-address	d-character
RT	<u>M</u>	%Ux	xxx	R

*Function.* The tape unit specified in the A-address is started. The d-character specifies a tape read operation. The B-address specifies the high-order position of the tape read-in area of storage. The machine begins to read magnetic tape, and continues to read until either an inter-record gap in the tape record or a group-mark with a word-mark in core storage is sensed. The inter-record gap indicates the end of the tape record, and a group-mark (code CBA 8421) is inserted in core storage at this point.

If the group-mark with a word-mark occurs before the inter-record gap is sensed, the transfer of data from tape stops, but tape movement continues until the inter-record gap is sensed.

*Word Marks.* Word marks are not affected.

*Timing.*  $T = .0111 (L_1 + 1) \text{ ms} + T_M$ . (See *Magnetic-Tape Timing* for  $T_M$  time.)

*Address Registers After Operation.*

I-Add. Reg.	A-Add. Reg.	B-Add. Reg.
NSI	%4x	Group-mark + 1

*Example.* Read the record from tape unit 2 (labeled 2) into core storage. The high-order tape-record character is moved to INPUT (0419), the next character is moved to the next higher position (0420), etc., until transfer of data is stopped by an inter-record gap in the tape record, or a group-mark with a word-mark in core storage (Figure 38).

Autocoder		OPERAND							
Label	Operation	15	20	25	30	35	40	45	50
	RT	2	INPUT						

Assembled Instruction: M %U2 419 R

Figure 38. Read Tape (Move Operation)

## Read Tape with Word Marks

### Instruction Format.

Mnemonic	Op Code	A-address	B-address	d-character
RTW	<u>L</u>	%Ux	xxx	R

**Function.** This is the same as the read tape operation, except that word-separator characters on magnetic tape (written during WRITE TAPE WITH WORD MARKS instruction) are translated to word marks during transmission into core storage.

**Word Marks.** A word-separator character read from tape causes a word mark to be associated with the next tape character transferred into core storage (Figure 39).

Tape Positions	A	B	C	D
Tape Code	82	A841	41	C4
1440 Core-Storage Locations	A	B	C	
1440 Meaning	0	5	4	
1440 Core-Storage Code	C82	41W	4	

Figure 39. Word-Separator Character Handling during Read Tape with Word Marks Operation

**Timing.**  $T = .0111 (L_I + 1) \text{ ms} + T_M$ .

**Note.** If a record has been written on tape by a WRITE TAPE WITH WORD MARKS instruction, it should be read back by a READ TAPE WITH WORD MARKS instruction so that word-separator characters will be translated to word marks.

### Address Registers After Operation.

I-Add. Reg.	A-Add. Reg.	B-Add. Reg.
NSI	%4x	Group-mark + 1

**Example.** Read the record from tape unit 1 (labeled 1) into core storage, and insert word marks where word-separator characters exist in the tape record. The high-order character is moved to INREC1 (0518), the next character is moved to the next higher position (0519), etc., until the transfer of data is stopped by an inter-record gap in the tape record, or until a group-mark with a word-mark is sensed in 1440 core storage (Figure 40).

Autocoder									
Label	Operation	25	30	35	40	45	50	OPERAND	
1	RTW	1	INREC1						

Assembled Instruction: L %U1 518 R

Figure 40. Read Tape with Word Marks (Load Operation)

## Write Tape

### Instruction Format.

Mnemonic	Op Code	A-address	B-address	d-character
WT	<u>M</u>	%Ux	xxx	W

**Function.** The tape unit designated in the A-address is started. The d-character specifies a tape write operation. The data from core storage is written on the tape record. The B-address specifies the high-order position of the record in storage. A group-mark with a word-mark in core storage stops the operation. The group-mark with a word-mark causes an inter-record gap on the tape.

**Word Marks.** Word marks are not affected.

**Timing.**  $T = .0111 (L_I + 1) \text{ ms} + T_M$ .

**Note.** If a group-mark with a word-mark is the first character of B-address, the tape-adaptor unit and the tape unit will hang up. The condition can be reset by pressing the start-reset key if the tape-select switch on the system console is in the N (normal) position.

### Address Registers After Operation.

I-Add. Reg.	A-Add. Reg.	B-Add. Reg.
NSI	%4x	Group-mark + 1

**Example.** Transfer the contents of core storage to tape unit 1 (labeled 1), starting at the location labeled OUTPUT (0525) and ending at the location of the first group-mark with a word-mark (Figure 41).

Autocoder									
Label	Operation	25	30	35	40	45	50	OPERAND	
1	WT	1	OUTPUT						

Assembled Instruction: M %U1 525 W

Figure 41. Write Tape (Move Operation)

## Write Tape with Word Marks

### Instruction Format.

Mnemonic	Op Code	A-address	B-address	d-character
WTW	<u>L</u>	%Ux	xxx	W

**Function.** This is the same as the write tape operation except that the WRITE TAPE WITH WORD MARKS instruction affects word marks in core storage.

**Word Marks.** A word mark associated with any position in core storage causes a word-separator character (A841) to be written automatically on tape, one character ahead of that which contained the word mark. Thus, word marks are translated to word-separator characters for tape storage (Figure 42).

1440 Core-Storage Locations	A	B	C	D
1440 Core-Storage Code	C82	41W	4	
1440 Meaning	0	5	4	
Tape Positions	A	B	C	D
Tape Code	82	A841	41	C4

Figure 42. Word-Separator Character Handling during Write Tape with Word Marks Operation

Timing.  $T = .0111 (L_I + 1) \text{ ms} + T_M$ .

Note. Load operations must be used when word marks are needed for identification in tape storage. If tape is written by a WRITE TAPE WITH WORD MARKS instruction, it must be read back by a READ TAPE WITH WORD MARKS instruction to insure proper translation between the tape and core storage.

**Address Registers After Operation.**

I-Add. Reg.          A-Add. Reg.          B-Add. Reg.  
 NSI                    %4x                    Group-mark + 1

Example. Transfer the contents of core storage to tape unit 2 (labeled 2). Insert a word-separator character where word marks exist in core storage, beginning at OUTREC (0696) and ending at the first group-mark with a word-mark in core storage (Figure 43).

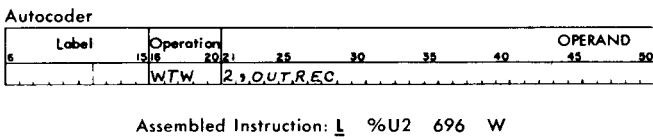

Figure 43. Write Tape with Word Marks

**Backspace Tape Record**

**Instruction Format.**

Mnemonic          Op Code          A-address          d-character  
 BSP                    U                    %Ux                    B

Function. The tape unit specified in the A-address backspaces over one tape record. The first inter-record gap (IRG) encountered stops the backspace operation specified by the d-character, B.

Word Marks. Word marks are not affected.

Timing.  $T = .0111 (L_I + 1) \text{ ms} + T_M$ \*

- \*Backspace after Read operation:  
 (428 + .050 N) ms
- Backspace after Write operation:  
 (435 + .050 N) ms

Note. Processing unit not interlocked during tape-movement time.

**Address Registers After Operation.**

I-Add. Reg.          A-Add. Reg.          B-Add. Reg.  
 NSI                    %4x                    dbb

Example. Backspace tape unit 1 (labeled 1) until an IRG is sensed (Figure 44).

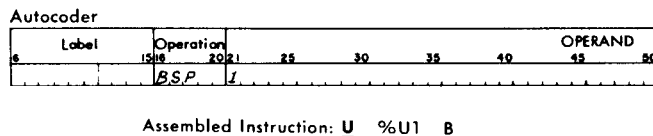

Figure 44. Backspace Tape Record

**Skip and Blank Tape**

**Instruction Format.**

Mnemonic          Op Code          A-address          d-character  
 SKP                    U                    %Ux                    E

Function. The tape unit, designated by the A-address, spaces forward and erases approximately 4 inches of tape. The actual skip occurs when the next WRITE TAPE instruction is given. This instruction makes it possible to bypass defective tape areas.

Word Marks. Word marks are not affected.

Timing.  $T = .0111 (L_I + 1) \text{ ms}$ . Processing can continue immediately after this operation. However, 110 ms must be added to the next WRITE TAPE instruction time.

Notes. The SKIP AND BLANK TAPE instruction should be given immediately preceding a WRITE TAPE instruction for the tape unit specified by both instructions. The processing unit is not interlocked during tape-movement time.

**Address Registers After Operation.**

I-Add. Reg.          A-Add. Reg.          B-Add. Reg.  
 NSI                    %4x                    dbb

Example. Erase tape on tape unit 1 (labeled 1) when the next write operation is ordered for that unit (Figure 45).

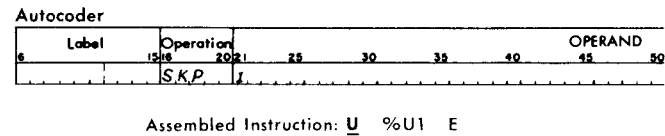

Figure 45. Skip and Blank Tape

**Write Tape Mark**

**Instruction Format.**

Mnemonic          Op Code          A-address          d-character  
 WTM                    U                    %Ux                    M

Function. This instruction causes a tape mark character (C8421) to be recorded immediately following the last record on tape. When the tape mark is read back from a tape, the end-of-reel indicator is turned on. This signals the system program that the end of a major group of records has been reached (end-of-file) or the end of utilized tape has been reached.

Word Marks. Word marks are not affected.

Timing.  $T = .0111 (L_I + 1) \text{ ms} + T_M$ .

Note. Processing unit not interlocked during tape-movement time.

**Address Registers After Operation.**

I-Add. Reg.          A-Add. Reg.          B-Add. Reg.  
 NSI                    %4x                    dbb

*Example.* Insert a tape mark on the tape in tape unit 2 (labeled 2), Figure 46.

Autocoder		OPERAND							
Label	Operation	20	21	25	30	35	40	45	50
	WTM	2							

Assembled Instruction: U %U2 M

Figure 46. Write Tape Mark

### Diagnostic Read

#### Instruction Format

Mnemonic	Op Code	A-address	d-character
None	<u>U</u>	%Bx	A

*Function.* This instruction causes the tape unit specified in the A-address to reposition its tape to the next inter-record gap (IRG) without transmitting any data to core storage. If the tape record contains a first character tape mark, the end-of-file (EOF) indicator is turned on.

This instruction is useful in skipping records or files on tape. The system is free to proceed with internal processing during the tape movement.

The tape operations are interlocked until the check character of the record being skipped is sensed.

*Word Marks.* Word marks are not affected.

*Timing.*  $T = .0111 (L_I + 1) \text{ ms} + T_M$ .

*Note.* Processing unit not interlocked during tape-movement time.

#### Address Registers After Operation.

I-Add. Reg.	A-Add. Reg.	B-Add. Reg.
NSI	% 2x	dbb

### Rewind Tape

#### Instruction Format.

Mnemonic	Op Code	A-address	d-character
RWD	<u>U</u>	%Ux	R

*Function.* This instruction is usually given after an end-of-reel condition, and causes the selected tape unit to rewind its tape. When the operation is initiated, the tape unit is, in effect, disconnected from the system.

*Word Marks.* Word marks are not affected.

*Timing.*  $T = .0111 (L_I + 1) \text{ ms}$ . Rewind time is 13.3 minutes, but it is not calculated with program time. Processing can continue immediately after this instruction is interpreted.

*Note.* Processing unit not interlocked during tape-movement time.

#### Address Registers After Operation.

I-Add. Reg.	A-Add. Reg.	B-Add. Reg.
NSI	% 4x	dbb

*Example.* Rewind the tape in tape unit 1 (labeled 1), Figure 47.

Autocoder		OPERAND							
Label	Operation	20	21	25	30	35	40	45	50
	RWD	1							

Assembled Instruction: U %U1 R

Figure 47. Rewind Tape

### Rewind Tape and Unload

#### Instruction Format.

Mnemonic	Op Code	A-address	d-character
RWU	<u>U</u>	%Ux	U

*Function.* This instruction causes the tape unit specified in the A-address to rewind its tape. At the end of the rewind, the tape is out of the vacuum columns, and the reading mechanism is disengaged. The unit is effectively disconnected from the system, and is not available again until the operator restores it to a ready status.

*Word Marks.* Word marks are not affected.

*Timing.*  $T = .0111 (L_I + 1) \text{ ms}$ . Rewind time is 2.2 minutes, but it is not calculated with program time. Processing can continue immediately after this instruction is interpreted.

*Note.* Processing unit not interlocked during tape-movement time.

#### Address Registers After Operation.

I-Add. Reg.	A-Add. Reg.	B-Add. Reg.
NSI	% 4x	dbb

*Example.* Rewind the tape in tape unit 2 (labeled 2), and make it unavailable to the stored program, at the completion of the rewind operation (Figure 48).

Autocoder		OPERAND							
Label	Operation	20	21	25	30	35	40	45	50
	RWU	2							

Assembled Instruction: U %U2 U

Figure 48. Rewind Tape and Unload

### Branch if End of Reel

#### Instruction Format.

Mnemonic	Op Code	I-address	d-character
BEF	<u>B</u>	xxx	K

**Function.** The end-of-reel indicator (EOR) turns on in the system processing unit if a tape mark is read by the system or if a *reflective spot* is sensed during a write tape operation. This instruction tests the indicator and causes an automatic branch to the I-address if the indicator is ON. If it is OFF, the program continues normally.

**Word Marks.** Word marks are not affected.

**Timing.**

No Branch:

$$T = .0111 (L_I + 1) \text{ ms.}$$

Branch (without indexing):

$$T = .0111 (L_I + 1) \text{ ms.}$$

Branch (with indexing):

$$T = .0111 (L_I + 2) \text{ ms.}$$

**Note.** This instruction must be executed immediately after testing for a tape error, following a tape read or tape write operation to ensure correct results and reset the EOR indicator OFF, if it is ON. If another tape unit is selected before a BRANCH IF END-OF-REEL INDICATOR ON instruction is executed, the indicator remains ON and a false EOR condition specifying the wrong tape unit results.

**Address Registers After Operation.**

I-Add. Reg.	A-Add. Reg.	B-Add. Reg.	
No Branch	NSI	BI	dbb
Branch (without indexing)	NSI	BI	Blank
Branch (with indexing)	NSI	BI	NSI

**Example.** Test the tape unit just used for an end-of-reel condition. If there is an EOR condition, branch to TAPER1 (0685) for the next instruction. If no EOR exists, continue the program with the next sequential instruction (Figure 49).

Autocoder									
6	15	20	25	30	35	40	45	50	
Label	Operation		OPERAND						
	BEF	TAPER1							

Assembled Instruction: **B** 685 K

Figure 49. Branch If End of Reel

### Branch if Tape Error

**Instruction Format.**

Mnemonic	Op Code	I-address	d-character
BER	<u>B</u>	xxx	L

**Function.** If an error occurs in transmission between a tape unit and the system during a tape read or tape write operation, an error indicator turns on in the system and the tape light on the console glows red. This instruction tests the error indicator, and branches to the I-address for the next instruction if the indicator is ON. If it is OFF, the program continues with the next sequential instruction.

**Word Marks.** Word marks are not affected.

**Timing.**

No Branch:

$$T = .0111 (L_I + 1) \text{ ms.}$$

Branch (without indexing):

$$T = .0111 (L_I + 1) \text{ ms.}$$

Branch (with indexing):

$$T = .0111 (L_I + 2) \text{ ms.}$$

**Notes.** The BRANCH IF TAPE ERROR instruction must be given after a tape read or write operation, because any tape operation on any tape unit causes the indicator to turn off. The information read from tape always enters core storage with odd-bit parity. Therefore, the tape read-in area need not be cleared after a tape read error has occurred.

**Address Registers After Operation.**

I-Add. Reg.	A-Add. Reg.	B-Add. Reg.	
No Branch	NSI	BI	dbb
Branch (without indexing)	NSI	BI	Blank
Branch (with indexing)	NSI	BI	NSI

**Example.** Read a tape record from the tape unit 1 (labeled 1) into core-storage area labeled TAPEIN (0629) and test for a tape error. If there is an error, branch to TAPER2 (0539) for the next instruction. If there is no error, continue processing with the next sequential instruction (Figure 50).

Autocoder									
6	15	20	25	30	35	40	45	50	
Label	Operation		OPERAND						
	RT	1, TAPEIN							
	BER	TAPER2							

Assembled Instruction: **M** %U1 629 R  
**B** 539 L

Figure 50. Branch If Tape Error

### Read Binary Tape

**Instruction Format.**

Mnemonic	Op Code	A-address	B-address	d-character
RTB	<u>M</u>	%Bx	xxx	R

**Function.** A tape record written in binary form is read into core storage, beginning at the location specified by the B-address and ending at an inter-record gap between tape records or a group-mark with a word-mark in core storage. The A-address indicates the tape unit selected, and signals the column-binary tape operation. The d-character (R) specifies a read operation.

**Word Marks.** Word marks are not affected.

**Timing.**  $T = .0111 (L_I + 1) \text{ ms} + T_M$ .



### Address Registers After Operation.

I-Add. Reg.                      A-Add. Reg.                      B-Add. Reg.  
 NSI                                      %2x                                      Group-mark + 1

*Example.* Read the binary tape record from the tape unit labeled 1 into the area of core storage labeled BTPIN (2080) and ending at the group-mark with a word-mark sensed in core storage or at the first inter-record gap encountered in the tape record (Figure 51).

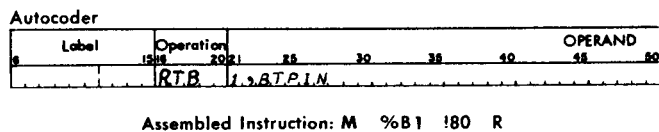

Figure 51. Read Binary Tape

### Write Binary Tape

#### Instruction Format.

Mnemonic    Op Code    A-address    B-address    d-character  
 WTB            M            %Bx            xxx            W

*Function.* This instruction writes a tape record in the odd-parity mode. The A-address specifies the tape unit to be selected, and signals that this is a binary-tape operation. The B-address specifies the high-order position of the tape record in core storage. The d-character indicates a tape-write operation. The sensing of a group-mark with a word-mark in core storage stops transmission from the system to the tape unit.

*Word Marks.* Word marks are not affected.

*Timing.*  $T = .0111 (L_I + 1) \text{ ms} + T_M$ .

#### Address Registers After Operation.

I-Add. Reg.                      A-Add. Reg.                      B-Add. Reg.  
 NSI                                      %2x                                      Group-mark

*Example.* Write a tape record in the binary mode on the tape unit labeled 2, with the data stored in the area labeled BTPOUT (2001) and ending at the group-mark with a word-mark sensed in core storage (Figure 52).

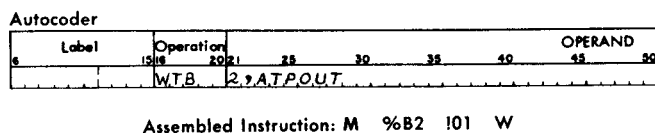

Figure 52. Write Binary Tape

### Magnetic-Tape Timing

The tape units attached to the 1440 system are under the control of a tape-adaptor unit. This tape-adaptor

unit (TAU) can control the operation of only one tape unit at a time. If the one tape unit is busy, then the other tape unit cannot be used until all operations on the busy one have been completed.

The following symbols and figures are used in the 7335 timing formulas:

The character rate of the 7335 at 556 characters per inch is .050 ms.

N is the number of characters in the record.

*Start time* is the time necessary for the tape unit to accelerate to operating speed.

*Stop time* is the time necessary for the tape unit to decelerate and stop.

*Record check time* is the time it takes to read or write the check character. This time is based on the read-write head gap (the distance that separates the read and write heads) and the time it takes a single character written on tape to travel from the write head to the read head.

*Load Point Time.* When reading or writing from load point, a space of 3.5 inches occurs prior to reading or writing a record and the start time is increased about 27 milliseconds.

### Read Operation Timing

During a 7335 tape-read operation, the tape-adaptor unit is interlocked  $20.5 + .050 N$  ms (Figure 53). This includes:

10.3 ms – start time  
 9.8 ms – stop time  
 .4 ms – record check time  
 .050N ms – record time  
20.5 + .050N ms

During the same read operation, the processing unit is interlocked for  $10.4 + .050N$  ms (Figure 53). This includes:

10.3 ms – start time  
 .1 ms – part of .4 ms record check time  
 .050N ms – record time  
10.4 + .050N ms

Therefore, in a tape-read operation, processing can take place during 10.1 ms of stop time and record-check time. A tape-transmission-error condition can be recognized .3 ms after the processing interlock is released.

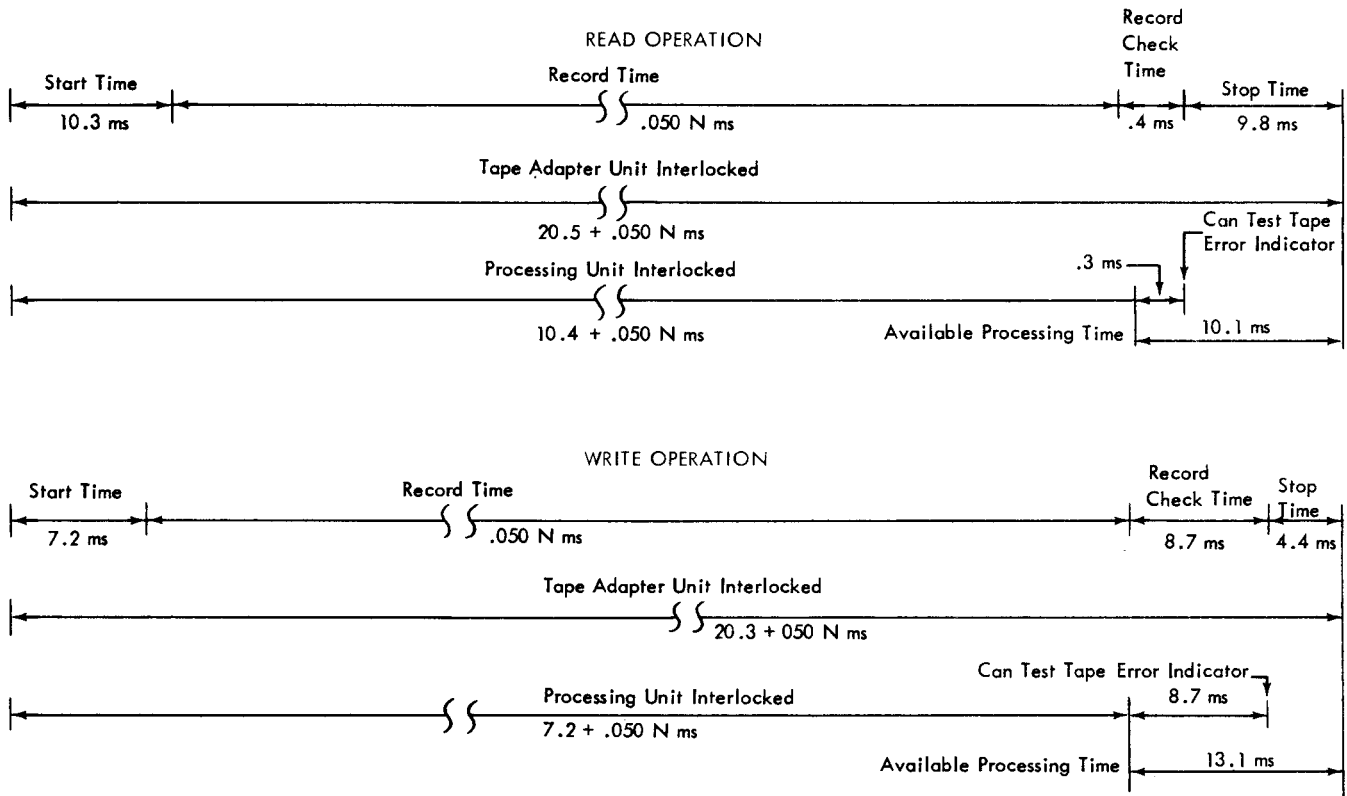

Figure 53. IBM 7335 Read-Write Operation Timing

### Write Operation Timing

During a 7335 tape-write operation, the tape-adaptor unit is interlocked  $20.8 + .050 N$  ms (Figure 53). This includes:

$$\begin{array}{r}
 7.2 \text{ ms} - \text{start time} \\
 4.4 \text{ ms} - \text{stop time} \\
 8.7 \text{ ms} - \text{record check time} \\
 .050N \text{ ms} - \text{record time} \\
 \hline
 20.3 + .050N \text{ ms}
 \end{array}$$

During the same write operation, the processing unit is interlocked for  $7.2 + .050 N$  ms (Figure 53). This includes:

$$\begin{array}{r}
 7.2 \text{ ms} - \text{start time} \\
 .050N \text{ ms} - \text{record time} \\
 \hline
 7.2 + .050N \text{ ms}
 \end{array}$$

Therefore, in a tape-write operation, processing can take place during the 13.1 ms record check and stop time. A tape-transmission-error condition can be recognized 8.7 ms after the processing interlock is released. If the tape-transmission-error test is given during the 8.7 ms record check time, the processing unit is interlocked until the error indicator is interrogated. The difference between the reading record check time of .4 ms and the writing record check time of 8.7 ms is due to the read-write head gap time (8.3 ms).

## Index of Instructions

Backspace Tape (1012)	26
Backspace Tape and Branch (1012)	27
Backspace Tape Record (729, 7330)	7
Backspace Tape Record (7335)	38
Branch if in Backspace Operation (1012)	27
Branch if End of Reel (729, 7330)	10
Branch if End of Reel (7335)	39
Branch if Indicator On (7340)	22
Branch if Input/Output Indicator On (1011)	25
Branch if Paper Tape Reader Ready (1011)	25
Branch if Tape Error (729, 7330)	10
Branch if Tape Error (7335)	40
Branch if Tape Punch Ready (1012)	27
Branch if Tape Punch not Ready to Accept Data (1012)	27
Branch if Tape Punch is not Ready to Read (1012)	28
Branch if Tape Punch Overextended (1012)	28
Branch if Supply Reel Low or Chad Box Full (1012)	29
Diagnostic Read (729, 7330)	9
Diagnostic Read (7335)	39
Read Binary Tape (7335)	40
Read from Paper Tape (1011)	24
Read from Paper Tape with Word Marks (1011)	24
Read Tape (729, 7330)	5
Read Tape (7335)	36
Read Tape with Word Marks (729, 7330)	6
Read Tape with Word Marks (7335)	37
Response (7340)	22
Rewind Tape (729, 7330)	9
Rewind Tape (7335)	39
Rewind Tape and Unload (729, 7330)	9
Rewind Tape and Unload (7335)	39
Skip and Blank Tape (729, 7330)	8
Skip and Blank Tape (7335)	38
Start Control (7340)	18
Start Read (7340)	20
Start Sense (7340)	18
Start Write (7340)	22
Tape Punch Read Back Check (1012)	26
Write Binary Tape (7335)	41
Write on Tape Punch (1012)	26
Write Tape (729, 7330)	6
Write Tape (7335)	37
Write Tape Mark (729, 7330)	8
Write Tape Mark (7335)	38
Write Tape with Word Marks (729, 7330)	6
Write Tape with Word Marks (7335)	37

**IBM**

**International Business Machines Corporation**

**Data Processing Division**

**112 East Post Road, White Plains, New York**